

INSTALLATION INSTRUCTION

Colorscaping Indicator Lights

2011/ 2021/ 2051/ 2071/ 2081/ 2091/ 2101/ 2111/ 2121/ 2131



WARNING

IMPORTANT: NEVER attempt to do any work without shutting off the electricity.

1. Read all instructions before installing.
2. System is intended for installation by a qualified electrician in accordance with the National Electrical Code and local regulations.
3. Place the wall switch in the "OFF" position.
4. Go to the main fuse box, or circuit breaker. Unscrew the fuse(s) or switch "OFF" the circuit breaker switch(es) that control the power to the space that you are working on.
5. Risk of electric shock. Install all luminaires 10 feet (3.05m) or more from a pool, spa or fountain.

CAUTION

- All parts must be used as indicated in these instructions. Do not substitute any parts, leave parts out, or use any parts that are worn out or broken. Failure to follow this instruction may invalidate the UL listing of this fixture.

AVERTISSEMENT

IMPORTANT: Coupez l'électricité avant TOUTE manipulation.

- Lisez toutes les instructions avant d'installer.
- Système est destiné à être installé par un électricien qualifié en conformité avec le code national de l'électricité et les règlements locaux.
- Placez l'interrupteur mural en position d'arrêt (« OFF »).
- Toujours mettre le fusible ou le disjoncteur en position arrêt dans la pièce ou des travaux électriques sont prévus

MISE EN GARDE

- Toutes les pièces doivent être utilisées tel qu'il est indiqué dans ces instructions. Ne remplacez pas les pièces, n'en laissez pas de côté et ne les utilisez pas si elles sont usées ou brisées. Le non-respect de ces instructions peut annuler l'homologation UL du luminaire.

ADVERTENCIA

IMPORTANTE: NUNCA intente hacer trabajos sin desconectar el suministro eléctrico.

- Lea y comprenda todas las instrucciones e ilustraciones por completo antes de proceder con el ensamblaje e instalación de esta lámpara.
- Sistema está diseñado para ser instalado por un electricista calificado, de acuerdo con el código eléctrico nacional y las normas locales.
- Coloque el interruptor de la pared en la posición "OFF" (APAGADO).
- Diríjase a la caja de fusibles o a la caja del interruptor de circuito principal en su hogar. Coloque el interruptor de alimentación principal en la posición "OFF" (APAGADO).

PRECAUCIÓN

- Todas las piezas deben usarse como lo indican estas instrucciones. No reemplace las piezas, no omita piezas durante la instalación ni utilice piezas gastadas o rotas. El incumplimiento de esta indicación podría invalidar la calificación UL esta lámpara.

THIS INSTRUCTIONS APPLY TO THE MODELS BELOW: *Note: Colorscaping Transformer is required to power the fixture. (sold separately)

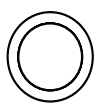

2011

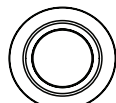

2021

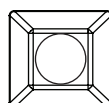

2051



2071

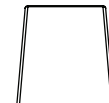

2081

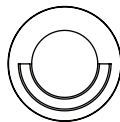

2091

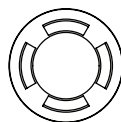

2101

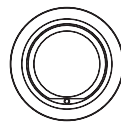

2111

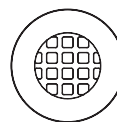

2121

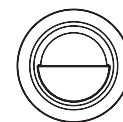

2131

Fixture Accessory (included in box)



Outdoor Rated Wire Nut
Model: **9020-WNT-BK**
Qty: 2pcs

waclighting.com
Phone (800) 526.2588
Fax (800) 526.2585

Headquarters/Eastern Distribution Center
44 Harbor Park Drive
Port Washington, NY 11050

Central Distribution Center
1600 Distribution Ct
Lithia Springs, GA 30122

Western Distribution Center
1750 Archibald Avenue
Ontario, CA 91761

INSTALLATION INSTRUCTION

Colorscaping Indicator Lights

2011/ 2021/ 2051/ 2071/ 2081/ 2091/ 2101/ 2111/ 2121/ 2131



SOFTSCAPE INSTALLATION

**Note: Colorscaping Transformer is required to power the fixture. (sold separately)*

1. Turn the main power off.
2. Dig a hole at the point of application. Make sure the hole measures roughly ØA^* in diameter and 4 inches in depth. (**Fig.1**)
3. Place a layer of pea gravel at the base of the hole to help with drainage.
4. Connect the fixture wires to landscape wires coming from the transformer using the outdoor rated direct burial wire nuts provided
5. Place the fixture in the hole and repack the soil to hold it in place. Make sure the trim is flush with the ground.

Fig.1

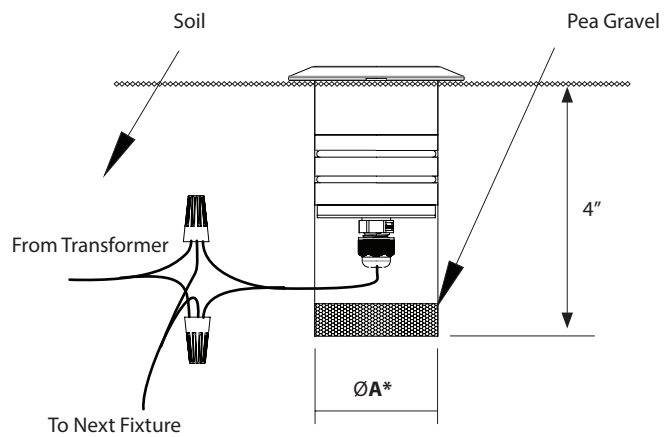

For model # 2011/2021/2051/2071/2081/2091/2101/2111/2121/2131

A* = $\text{Ø}2$ in.

HARDSCAPE INSTALLATION

**Note: Colorscaping Transformer is required to power the fixture. (sold separately)*

1. Turn the main power off.
2. Prepare a hole large enough (**B*** diameter) to fit a schedule 80 pipe (not included). (**Fig.2**)
3. Install the pipe into the hole
4. Connect the fixture wires to low voltage wires coming from the transformer using the outdoor rated direct burial wire nuts provided.
5. Smear some plumbers' silicone (not included) on the O-rings of the fixtures to help keep moisture out.
6. Insert the fixture into the pipe, making sure the trim is flush with the mounting surface.

Fig.2

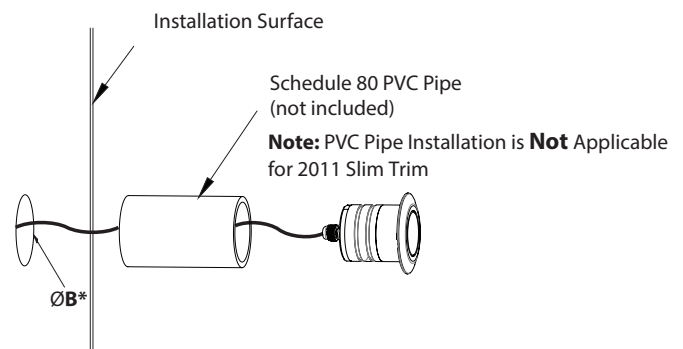

For model # 2021/2051/2071/2081/2091/2101/2111/2121/2131

B* = $\text{Ø}2.375$ in.

waclighting.com
Phone (800) 526.2588
Fax (800) 526.2585

Headquarters/Eastern Distribution Center
44 Harbor Park Drive
Port Washington, NY 11050

Central Distribution Center
1600 Distribution Ct
Lithia Springs, GA 30122

Western Distribution Center
1750 Archibald Avenue
Ontario, CA 91761

INSTALLATION INSTRUCTION

Colorscaping Indicator Lights

2011/ 2021/ 2051/ 2071/ 2081/ 2091/ 2101/ 2111/ 2121/ 2131



OUTDOOR WALL INSTALLATION

**Note: Colorscaping Transformer is required to power the fixture. (sold separately)*

1. Turn the main power off.
2. Attach the spring clip using the provided clip screws.
3. Cut a hole at the installation location. (**Fig.3**)
4. Connect the fixture wires to low voltage wires coming from the transformer using the outdoor rated direct burial wire nuts provided.
5. Smear some plumbers' silicone (not included) on the O-rings of the fixtures to help keep moisture out.
6. Insert the fixture into the hole, making sure the trim is flush with the mounting surface

Fig.3

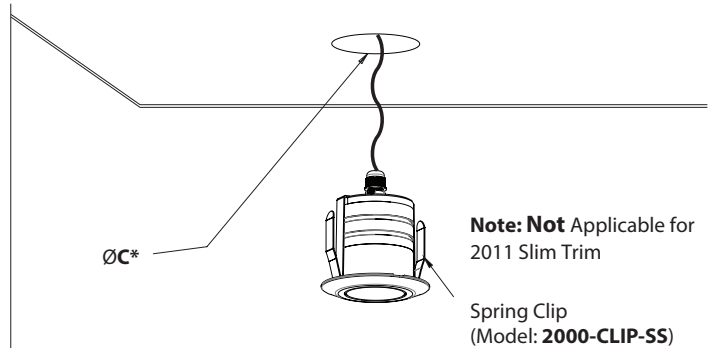

For model # 2021/2051/2071/2081/2091/2101/2111/2121/2131

C* = Ø2.25 in.

INSTALLATION INSTRUCTION

Colorscaping Indicator Lights

2011/ 2021/ 2051/ 2071/ 2081/ 2091/ 2101/ 2111/ 2121/ 2131



CONCRETE POUR INSTALLATION

**Note: Transformer is required to power the fixture. (sold separately)*

1. Turn the main power off.
2. Install wiring and conduit (use ½" NPT) at desired position, plug all un-used holes. Refer to applicable wiring diagram. **(Fig.5)**
3. Secure 4" weatherproof junction box to the ground, preferably over a layer of sand or pea gravel for drainage.
4. Cut Schedule 80 PVC Pipe in excess length for planned concrete thickness. (An 18" long pipe is supplied with concrete pour kit)
**Make sure the cut end is put into the concrete pour kit*
5. Insert the PVC pipe into the mounting flange and lock it with screws
6. Secure concrete pour kit onto the 4" junction box.
7. Pour desired amount of concrete, making sure **NO CONCRETE ENTERS THE BOX. (Fig.6)**
8. After the concrete has cured, cut off excess PVC pipe protruding from the ground. **(Fig.7)**
9. Connect fixture wires to box wires using the outdoor rated direct burial wire nuts. **(Fig.8)**
10. Smear plumbers' silicone (not included) to O-rings.
11. Insert LED Fixture into flange with a twisting motion. Make sure the trim is flush with the top of the poured concrete.
12. To remove fixture, use a small flat head screwdriver and pry it from the flange. **(Fig.9)**

Fig.5

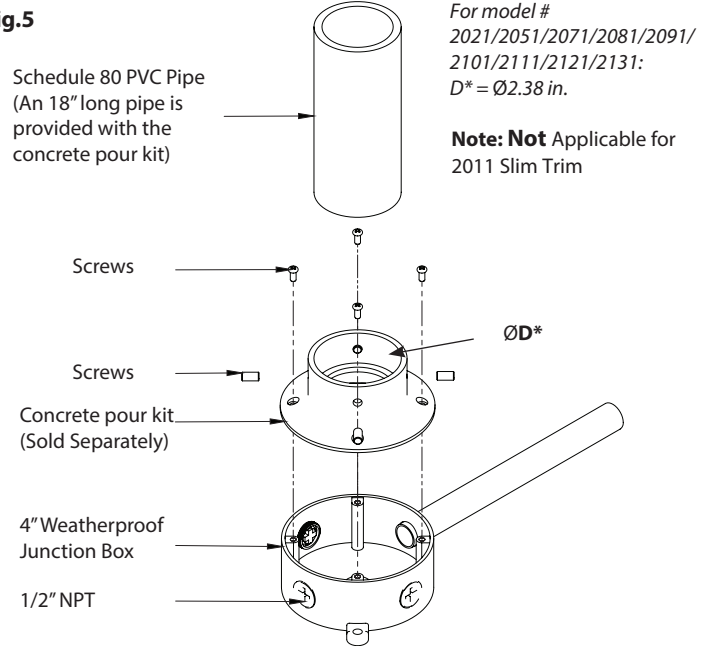

Fig.6

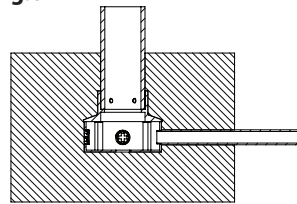

Fig.7

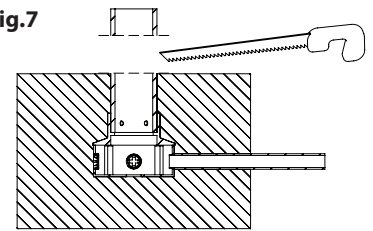

Fig.8

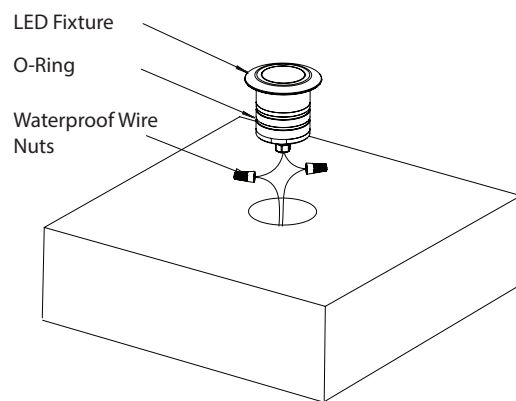

Fig.9

