

INVISILED® PRO

24V LED Tape Light

WAC



Tape Section



3 LED "L" Connector

Fixture Type:

Catalog Number:

Project: _____

Location: _____

PRODUCT DESCRIPTION

Professional grade white tape light that delivers optimal color consistency and brightness. An ideal dimmable system for task or accent lighting application in residential, hospitality and commercial environments.

FEATURES

- Can be field cut, male to male adapter required to re-use female side
- Ultra thin profile at 3/8"
- Diodes spaced evenly at 1" on center
- Minimum run length of 1'
- May be field cut every 2" at the end of a run
- Three mounting methods provided for different surfaces
- Specially rated for installation in the storage area of a clothes closet
- 50,000 hour rated life
- 5 year WAC Lighting product warranty

SPECIFICATIONS

- Construction:** Flexible silicone-cased tape light, peel-and-stick 3M construction adhesive, indicating marks on back for field cutting
- Light Source:** 12 LEDs per foot, Runs on 24V at 3W per foot
- Operating Temp:** -4°F – 122°F (-20°C – 50°C), relative humidity 95%
- Standards:** UL & cUL Listed for Damp Locations

ORDER NUMBER – TAPE SECTION

Model	Watts/ft	Color Temp	CRI	Lumens/ft	Length	Qty	Tape Color
LED-T24 3	W	2700K	85	200	2IN	2 inches	1
	P	3000K	85	200	2IN-10	2 inches	10
	35	3500K	85	207	1	1 foot	1
	1-40	4500K	85	215	1-40	1 foot	40
	5				5	5 feet	1
							WT White

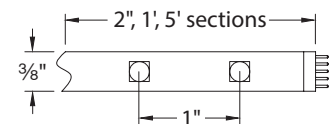

LED-T24__ - __-WT

Example: **LED-T24P-2IN-10-WT**

ORDER NUMBER – 3 LED "L" CONNECTOR

Model	Watts/ft	Color Temp	CRI	Lumens/ft	Tape Color
LED-T24 1.2	W	2700K	85	50	3L-WT White
	P	3000K	85	50	
	35	3500K	85	52	
	C	4500K	85	54	

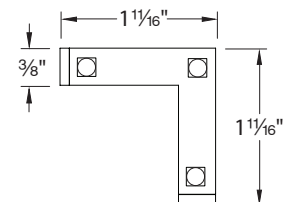

LED-T24__ -3L-WT

Example: **LED-T24C-3L-WT**

wacighting.com

Phone (800) 526.2588

Fax (800) 526.2585

Headquarters, East Manufacturing Facility

44 Harbor Park Drive

Port Washington, NY 11050

South East Manufacturing Facility

1600 Distribution Ct

Lithia Springs, GA 30122

Central Manufacturing Facility

1700 South J Elmer Freeway, Ste 100

Cedar Hill, TX 75104

West Manufacturing Facility

1750 S Archibald Ave







Ontario, CA 91761

INVISILED® PRO



24V LED Tape Light



Class 2 Power Supply (Required)

Model	Input	Output	Max Run	Dimming	Description	
 EN-2460-RB2-T EN-24100-RB2-T	Remote	120VAC 120VAC	24VAC / 60W 24VAC / 96W	20' 33'	100%-5% ELV	Includes a 6' lead wire. UL Class 2 output.
 PS-24DC-U60R-T PS-24DC-U96R-T	Remote	120-277VAC	24VDC / 60W 24VDC / 96W	20' 33'	100%-5% ELV, TRIAC	Includes a 6' lead wire. UL Class 2 output.
 PS-24DC-U3X96R-T	Remote	120-277VAC	24VDC / 3 X 96W	33'	100%-5% ELV, TRIAC, 0-10V	Includes a 6' lead wire. Overload and short circuit protection.
 EN-24100-277-RB2-T	Remote	277VAC	24VDC / 96W	33'	100%-5% 0-10V	Includes a 6' lead wire. UL Class 2 output.
 EN-2460-P-AR-T EN-24100-P-AR-T	Plug-in	120VAC 120VAC	24VAC / 60W 24VAC / 96W	20' 33'	Non Dimmable	Includes a 6' lead wire. UL Class 2 output.
 EN-D24100-120-R	Wall Dimmer & Driver	120VAC	24VDC / 96W	33'	Integral	UL Class 2 output.

Indoor Controller

Model	Description
 CT-6A-R2	Pro, Pro2, Pro3, LITE Touch Panel and Motion Sensor Includes a Touch Panel, Occupancy Sensor and a Controller. AC/DC input at 12V(60W Max) or 24V(96W Max). Connect on secondary side of driver/transformer.
 IR-96-24VACDC-WT IR-96-24VACDC-BK	White Black IR Sensor IR (Infrared sensor) switch works by turning the light on when it becomes unobstructed.

Smart Control

Model	Description
 CT-96-SM	InvisiLED® Smart Home Kit Transform your interiors with the InvisiLED® Smart Home Kit, designed exclusively for InvisiLED Lite, Pro, Pro 2 and Pro 3 Tape. Control your LED tape seamlessly via Wi-Fi using the MyWAC app with devices you already own, including Amazon Alexa and Google Home. Offers on/off activation and up/down dimming capability for 24VDC systems and high-output tape lighting applications. Or use DMX to control your popular control platforms. Includes a 96W 24VDC Power Supply (EN-24DC096-UNV-RB2), wireless controller (CTR-WDMX-24VDC) and a ready-to-connect lead wire with an InvisiLED Connector (LED-TC-B-2-WT)

Model	Input	Description
 LED-WCT-WT	120-230VAC	<ul style="list-style-type: none"> - Multi-scene selection - Raise/Lower, dedicated Off button - Suitable for standard single NEMA wall box Setup and configuration via MyWAC mobile application - no physical adjustment needed - cUL listed

EXAMPLE INSTALLATION FOR WIRELESS AND DMX CONTROL

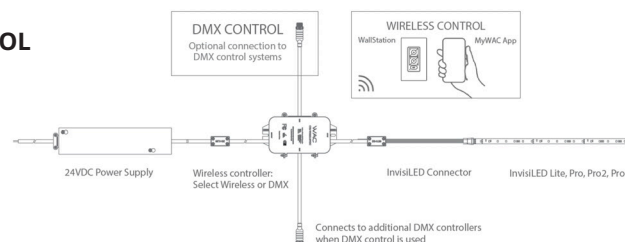

wacighting.com	Headquarters, East Manufacturing Facility	South East Manufacturing Facility	Central Manufacturing Facility	West Manufacturing Facility
Phone (800) 526.2588	44 Harbor Park Drive	1600 Distribution Ct	1700 South J Elmer Freeway, Ste 100	1750 S Archibald Ave
Fax (800) 526.2585	Port Washington, NY 11050	Lithia Springs, GA 30122	Cedar Hill, TX 75104	Ontario, CA 91761

Indoor Electrical Accessories

	Model	Dimension	Finish	Description
	LED-TC-WEXT-144	12 ft	Black	In Wall Rated Extension Cable Extends distance between a hard wired power supply or a wiring box to a tape section.
	LED-TC-WEXT-144-WT	12 ft	White	
	LED-TC-WEXT-240	20 ft	Black	
	LED-TC-WEXT-240-WT	20 ft	White	
	LED-TC-WIC-144	12 ft	Black	In Wall Rated Joiner Cable Connects tape sections. 2 female ends. 1 male to male connector included.
	LED-TC-WIC-144-WT	12 ft	White	
	LED-TC-WIC-240	20 ft	Black	
	LED-TC-WIC-240-WT	20 ft	White	
	LED-TC-P-2	2 ft	Black	Lead Wire Alternative lengths for plug-in power supplies.
	LED-TC-P-2-WT	2 ft	White	
	LED-TC-P-12	12 ft	Black	
	LED-TC-P-12-WT	12 ft	White	
	LED-TC-EXT-144	12 ft	Black	Extension Cable Extends distance between a hard wired power supply or a wiring box to a tape section.
	LED-TC-EXT-144-WT	12 ft	White	
	LED-TC-B-2	L: 1½ in W: ¾ in H: ⅞ in	Black White	Low Voltage Wiring Box With Feed Neatly houses connections for up to two wires with 12" female feed.
	LED-TC-B-2-WT			
	LED-T-B	L: 1½ in W: ¾ in H: ⅞ in	White	Low Voltage Wiring Box Neatly houses connections for up to two wires.
	TB-S	L: 6¼ in W: 1¾ in H: 1¼ in	White	Wiring Box With Switch Use when spanning a large gap in a system layout without leaving exposed wiring. Optional switch included.

Compatible with Pro, Pro2, Pro3

	Model	Dimension	Finish	Description
	LED-TC-IC2	2 in	Black	Joiner Cable Connects tape sections.
	LED-TC-IC2-WT	2 in	White	
	LED-TC-IC6	6 in	Black	
	LED-TC-IC6-WT	6 in	White	
	LED-TC-IC12	12 in	Black	
	LED-TC-IC12-WT	12 in	White	
	LED-TC-IC36	36 in	Black	
	LED-TC-IC36-WT	36 in	White	
	LED-TC-IC72	72 in	Black	
LED-TC-IC72-WT	72 in	White		



LED-TC-MM

50 Qty

Black

Connector
Male to male connector.

Compatible with Pro, Pro2, Pro3, LITE. Change directionality of tape runs and reuse cut ends of tape.

	Model	Finish	Description
	LED-TC-Y	Black	3-Way "Y" Connector Connects tape sections.
	LED-TC-Y-WT	White	
	LED-TC-X	Black	4-Way "X" Connector Connects tape sections.
	LED-TC-X-WT	White	
	LED-TC-L	Black	"L" Connector Connects tape sections.
	LED-TC-L-WT	White	
	LED-TC-EC	Black	End Cap 1 cut and 1 male end cap.
	LED-TC-EC-WT	White	

Compatible with Pro, Pro2, Pro3, LITE.

	Model	Dimension	Finish	Description
	T24-OD-SW60	5 ft	Black	DMX Joiner Cable - Satellite Connect between CTR-WDMX-24VDC Master to Satellite
	T24-OD-SW120	10 ft		
	T24-OD-MW60	5 ft	Black	DMX Joiner Cable Connect between DMX Universe to CTR-WDMX-24VDC
	T24-OD-MW120	10 ft		

wacighting.com
Phone (800) 526.2588
Fax (800) 526.2585

Headquarters, East Manufacturing Facility
44 Harbor Park Drive
Port Washington, NY 11050

South East Manufacturing Facility
1600 Distribution Ct
Lithia Springs, GA 30122

Central Manufacturing Facility
1700 South J Elmer Freeway, Ste 100
Cedar Hill, TX 75104

West Manufacturing Facility
1750 S Archibald Ave
Ontario, CA 91761

INVISILED® PRO

Trimless Recessed Slim Channel

WAC

InvisILED Pro tape

- Installs within 5/8" drywall depth
- Linear channel can be field cut
- Accommodates either one or two runs of InvisILED Pro tape
- Includes a frosted acrylic diffuser

8FT LINEAR CHANNEL LED-T-RCH4-WT

Includes: 1 frosted diffuser
8 perforated metal sheets

POWER FEED LED-T-RBOX4-WT

The end cap may be placed on either side.
Hanger bars may be installed on any side of the wiring box.

Includes: 1 wiring box
2 hanger bars
2 end caps
2 channel connectors
1 counter sink drill bit
1 drill bit
2 power to tape connectors

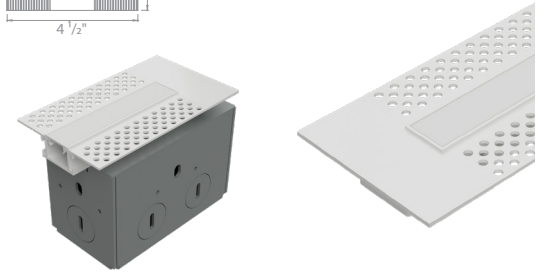
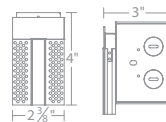
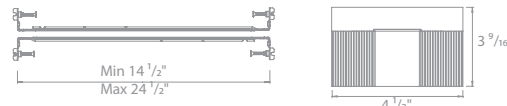
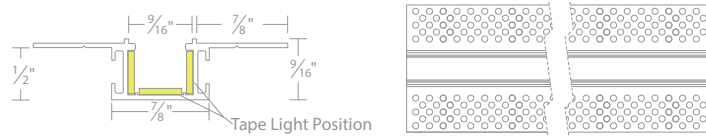

Trimmed Recessed Slim Channel

InvisILED Pro tape

- Installs within 5/8" drywall depth
- Linear channel can be field cut
- Accommodates either one or two runs of InvisILED Pro tape
- Includes a frosted acrylic diffuser

8FT LINEAR CHANNEL LED-T-RCH5-BK LED-T-RCH5-WT LED-T-RCH5-AL

Includes: 1 frosted diffuser
8 perforated metal sheets

POWER FEED LED-T-RBOX5-BK LED-T-RBOX5-WT LED-T-RBOX5-AL

The end cap may be placed on either side.
Hanger bars may be installed on any side of the wiring box.

Includes: 1 wiring box
2 hanger bars
2 end caps
2 channel connectors
1 counter sink drill bit
1 drill bit
2 power to tape connectors

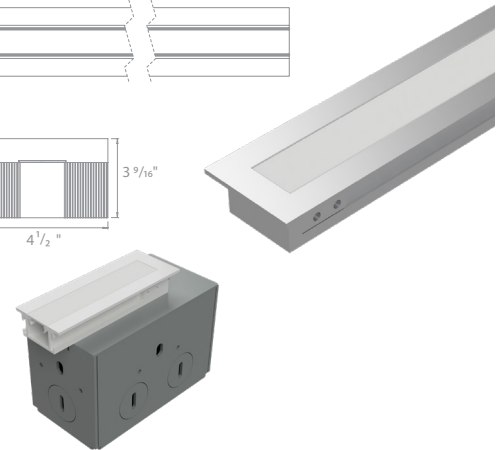
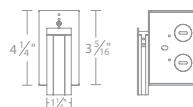
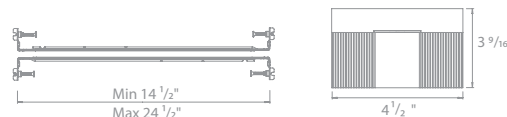
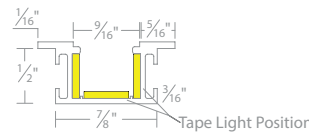

wacighting.com

Phone (800) 526.2588

Fax (800) 526.2585

Headquarters, East Manufacturing Facility

44 Harbor Park Drive

Port Washington, NY 11050

South East Manufacturing Facility

1600 Distribution Ct

Lithia Springs, GA 30122

Central Manufacturing Facility

1700 South J Elmer Freeway, Ste 100

Cedar Hill, TX 75104

West Manufacturing Facility

1750 S Archibald Ave

Ontario, CA 91761

INVISILED® PRO

Symmetrical Recessed Channel

WAC

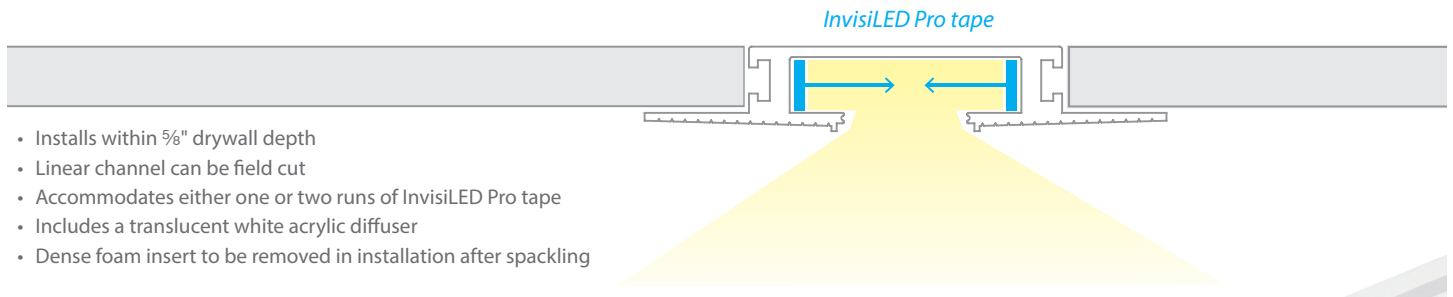

- Installs within 5/8" drywall depth
- Linear channel can be field cut
- Accommodates either one or two runs of InvisILED Pro tape
- Includes a translucent white acrylic diffuser
- Dense foam insert to be removed in installation after spackling

8FT LINEAR CHANNEL LED-T-RCH1-WT

Includes: 1 diffuser
8 perforated metal sheets

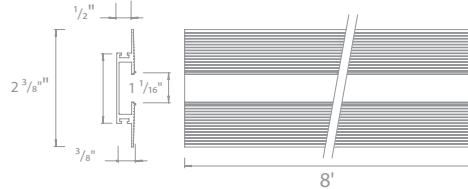

POWER FEED LED-T-RBOX1-WT

The end cap may be placed on either side.
Hanger bars may be installed on any side of the wiring box.

- Includes: 1 wiring box
2 hanger bars
4 five-pin InvisILED® adapters
2 end caps
1 diffuser
2 channel connectors
1 counter sink drill bit
1 drill bit
1 installation tool

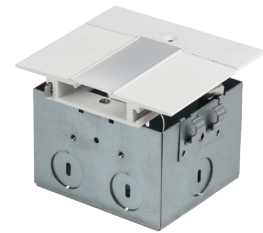
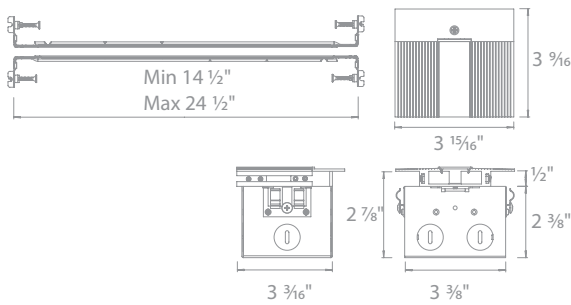

LATERAL CORNER LED-T-CTC1-WT

- Includes: 1 diffuser
2 channel connectors
2 perforated metal sheets

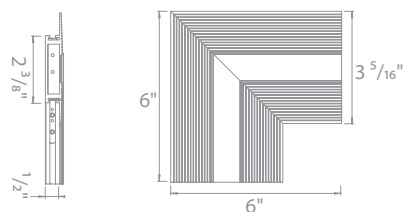

PERPENDICULAR CORNER LED-T-WTC1-WT

Transitions between walls or wall to ceiling

- Includes: 1 diffuser
2 channel connectors
2 perforated metal sheets

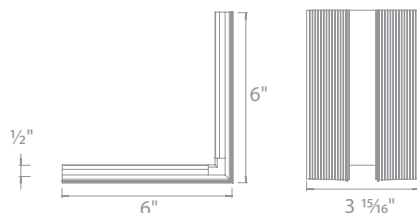

OUTSIDE CORNER LED-T-WTW1-WT

Transitions around columns, bump outs, or soffits

- Includes: 1 diffuser
2 channel connectors
2 perforated metal sheets

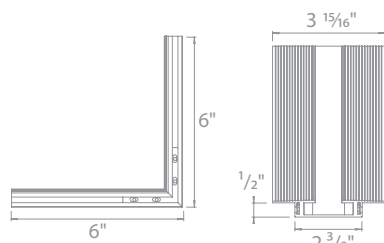

INVISILED® PRO

Asymmetrical Recessed Channel

WAC

- Installs within $\frac{5}{8}$ " drywall depth
- Linear channel can be field cut
- Accommodates one run of InvisILED Pro tape
- Dense foam insert to be removed in installation after spackling
- Recommended installation within 15 inches of surface to be illuminated



InvisILED Pro tape

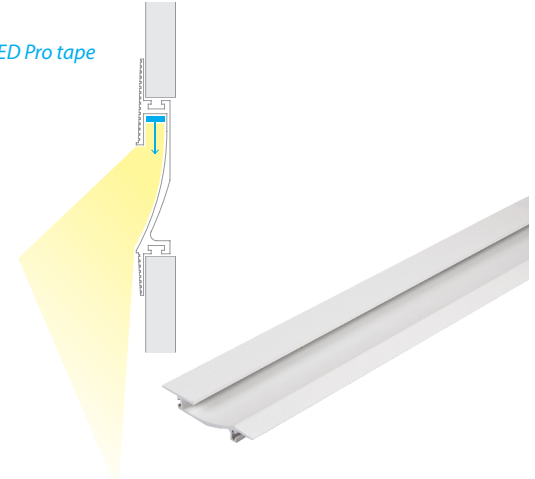

8FT LINEAR CHANNEL LED-T-RCH2-WT

Includes: 8 perforated metal sheets
2 channel connectors

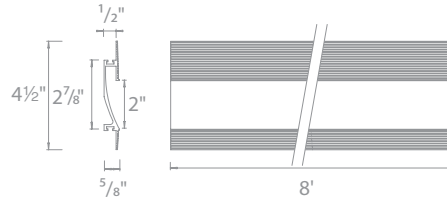

POWER FEED LED-T-RBOX2-WT

LED-T-RBOX2-WT

The end cap may be placed on either side. Hanger bars may be installed on any side of the wiring box.

- Includes: 1 wiring box
2 hanger bars
2 five-pin InvisILED® adapters
2 end caps (left and right)
2 channel connectors
1 counter sink bit
1 drill bit

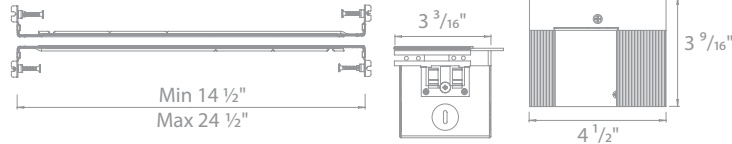

Indirect Recessed Slim Channel

- Linear channel can be field cut
- Dense foam insert to be removed in installation after spackling
- Allows option to use different color InvisILED Pro tape in one channel and switch them separately

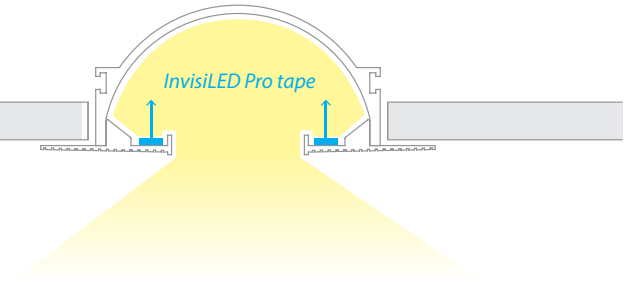
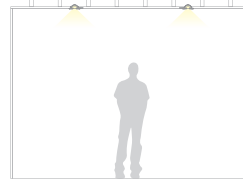

8FT LINEAR CHANNEL LED-T-RCH3-WT

Includes: 10 perforated metal sheets
2 channel connectors

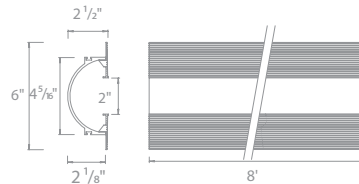

POWER FEED LED-T-RBOX3-WT

LED-T-RBOX3-WT

The end cap may be placed on either side.
Hanger bars may be installed on any side of the wiring box.

- Includes: 1 wiring box
2 hanger bars
4 five-pin InvisILED® adapters
1 end cap
2 channel connectors
1 counter sink bit
1 drill bit

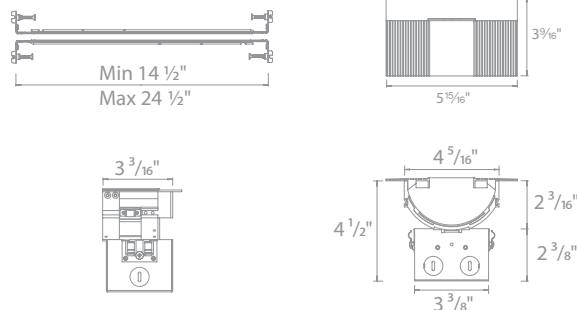

wacighting.com

Phone (800) 526.2588

Fax (800) 526.2585

Headquarters, East Manufacturing Facility

44 Harbor Park Drive

Port Washington, NY 11050

South East Manufacturing Facility

1600 Distribution Ct

Lithia Springs, GA 30122

Central Manufacturing Facility

1700 South J Elmer Freeway, Ste 100

Cedar Hill, TX 75104

West Manufacturing Facility

1750 S Archibald Ave

Ontario, CA 91761

INVISILED® PRO

Angled Recessed Channel

WAC

InvisILED Pro tape



- Recessed asymmetrical distribution provides a clean wash of illumination
- Linear channel can be field cut
- Accommodates one run of InvisILED Pro tape
- Includes a frosted acrylic diffuser

5FT LINEAR CHANNEL

LED-T-CH6-BK
LED-T-CH6-WT
LED-T-CH6-AL

ADDITIONAL END CAPS

LED-T-CH6-EC-BK
LED-T-CH6-EC-WT
LED-T-CH6-EC-AL

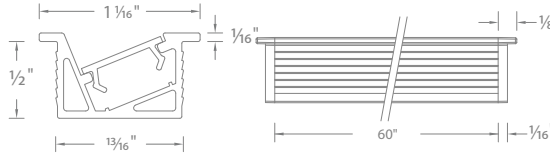

Includes: 1 frosted diffuser
2 end caps

Indoor Aluminum Channels

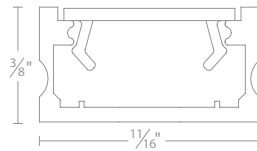

SHALLOW ALUMINUM CHANNEL

LED-T-CH5-BK
LED-T-CH5-WT
LED-T-CH5-AL

ADDITIONAL END CAPS

LED-T-CH5-EC-BK
LED-T-CH5-EC-WT
LED-T-CH5-EC-AL

Includes a diffuser, 2 end caps, and 5 screws.

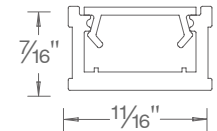

ALUMINUM CHANNEL ADDITIONAL END CAPS

LED-T-CH 5'
LED-T-CH-EC 2 pcs

Diffuses light from Gemini tape.
Includes a diffuser, 2 end caps, and 5 screws.

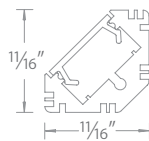

45° ANGLED ALUMINUM CHANNEL ADDITIONAL END CAPS

LED-T-CH2 5'
LED-T-CH2-EC 2 pcs

Includes a diffuser, 2 end caps, and 5 screws.

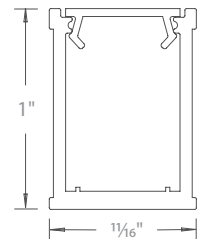

DEEP ALUMINUM CHANNEL ADDITIONAL END CAPS

LED-T-CH1 5'
LED-T-CH1-EC 2 pcs

Eliminates visible hot spots.
Includes a diffuser, 2 end caps, and 5 screws.

wacighting.com

Phone (800) 526.2588

Fax (800) 526.2585

Headquarters, East Manufacturing Facility

44 Harbor Park Drive

Port Washington, NY 11050

South East Manufacturing Facility

1600 Distribution Ct

Lithia Springs, GA 30122

Central Manufacturing Facility

1700 South J Elmer Freeway, Ste 100

Cedar Hill, TX 75104

West Manufacturing Facility

1750 S Archibald Ave

Ontario, CA 91761

INVISILED® PRO

Indoor Mounting Accessories

WAC



ALUMINUM RETROFIT CHANNEL LED-T-RC 3 feet

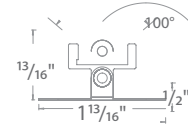

ADJUSTABLE CHANNEL CLIP LED-T-CL2-PT

Includes 2 pieces, 4 screws. Used to mount Aluminum Channel. Adjust 50° from center either way.

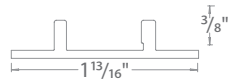

FIXED ANGLE CHANNEL CLIP LED-T-CL3-PT



Clip LED-T-CL **Curve Clip** LED-T-CL1

For surfaces that are difficult to adhere. Includes: 10 pcs plastic clips and 10 pcs screws. Compatible with InvisiLED Lite+, Pro+ and Pro2+ only.

Clips to hold indoor InvisiLED tapes sections. Includes: 10 pcs plastic clips and 10 pcs screws. Compatible with InvisiLED Lite+, Pro+ and Pro2+ only

Optical Channels and Lens Accessories



FROSTED DIFFUSER LED-T-CH5-COV-FR 5'
LED-T-CH8-COV-FR 8'

Standard diffuser included with channel.



SPOT OPTIC DEEP CHANNEL LED-T-CH3-SP 5'
ADDITIONAL END CAPS LED-T-CH1-EC 2 pcs

Eliminates visible hot spots. Includes a diffuser, 2 end caps, and 5 screws.

Spot 9° Beam Angle



SEMI-CLEAR DIFFUSER LED-T-CH5-COV-SF 5'
LED-T-CH8-COV-SF 8'

Optional diffuser available, order separately.

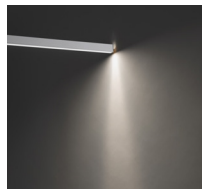

FLOOD OPTIC DEEP CHANNEL LED-T-CH3-FL 5'
ADDITIONAL END CAPS LED-T-CH1-EC 2 pcs

Eliminates visible hot spots. Includes a diffuser, 2 end caps, and 5 screws.

Flood 54° Beam Angle

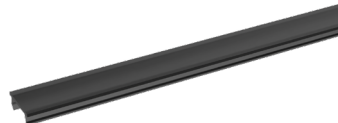

BLACK DIFFUSER LED-T-CH5-COV-BK 5'
LED-T-CH8-COV-BK 8'

Optional diffuser available, order separately.

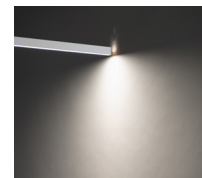

WIDE FLOOD OPTIC DEEP CHANNEL LED-T-CH3-WF 5'
ADDITIONAL END CAPS LED-T-CH1-EC 2 pcs

Eliminates visible hot spots. Includes a diffuser, 2 end caps, and 5 screws.

Wide Flood 84° Beam Angle

wacighting.com
Phone (800) 526.2588
Fax (800) 526.2585

Headquarters, East Manufacturing Facility
44 Harbor Park Drive
Port Washington, NY 11050

South East Manufacturing Facility
1600 Distribution Ct
Lithia Springs, GA 30122

Central Manufacturing Facility
1700 South J Elmer Freeway, Ste 100
Cedar Hill, TX 75104

West Manufacturing Facility
1750 S Archibald Ave
Ontario, CA 91761