

INVISILED® LITE+

24V LED Tape Light

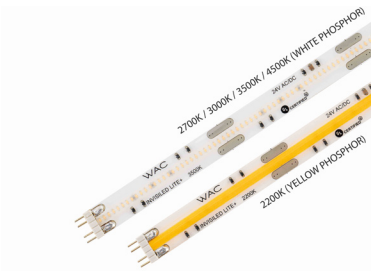

Tape Section

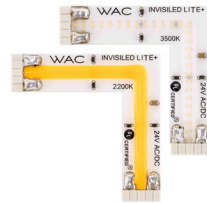

2700K / 3000K / 3500K / 4500K (WHITE PHOSPHOR)
2200K (YELLOW PHOSPHOR)

Fixture Type:

Catalog Number:

Project:

Location:

PRODUCT DESCRIPTION

Professional Grade White Tape Light delivers optimal color consistency and brightness, making it ideal for task or accent lighting in residential, hospitality, and commercial environments. This flexible and customizable system offers uniform illumination with the lowest profile, ensuring a seamless line of light and superior performance with premium light quality. Featuring a strong 3M adhesive bond for easy installation, it eliminates the need for additional diffused covers or accessories. Fully dimmable, it provides versatile lighting solutions tailored to your needs.

FEATURES

- Can be field cut, male to male adapter required to re-use female side
- Ultra thin profile at 3/8"
- Minimum run length of 1'
- May be field cut every 2" at the end of a run
- Three mounting methods provided for different surfaces
- Specially rated for installation in the storage area of a clothes closet
- 50,000 hour rated life
- 5 year WAC Lighting product warranty

SPECIFICATIONS

- Construction:** Flexible silicone-cased tape light, peel-and-stick 3M construction adhesive
- Cutting Interval:** 2"
- Operating Temp:** -4°F – 122°F (-20°C – 50°C), relative humidity 95%
- Standards:** UL & cUL Listed for Damp Locations, Title 24 Compliant

ORDER NUMBER – TAPE SECTION

Model	Watts/ft		Color Temp	CRI	Lumens/ft		Length		Qty	Tape Color
	@24VAC	@24VDC			@24VAC	@24VDC				
LED-TA24	2.2	1.35	22 2200K	90+	106.2	84.1	2IN	2 inches	1	White
			27 2700K		135	104.5	2IN-10	2 inches	10	
			30 3000K		140.3	110.7	1	1 foot	1	
			35 3500K		145	115	1-40	1 foot	40	
			45 4500K		149	118	5	5 feet	1	

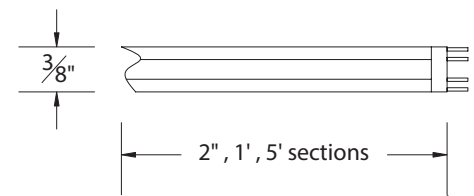

Example: **LED-TA2427-5**

ORDER NUMBER – TAPE "L" SECTION

Model	Watts/ft		Color Temp	CRI	Lumens/ft		Length	Tape Color
	@24VAC	@24VDC			@24VAC	@24VDC		
LED-TA24	0.36	0.22	22 2200K	90+	16.3	12.9	L	White
			27 2700K		19.9	15.5		
			30 3000K		21.2	16.5		
			35 3500K		23.8	18.7		
			45 4500K		23.6	18.6		

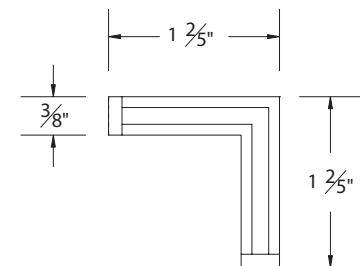

Example: **LED-TA2427-L**

wacighting.com

Phone (800) 526.2588

Fax (800) 526.2585

Headquarters, East Manufacturing Facility

44 Harbor Park Drive

Port Washington, NY 11050

South East Manufacturing Facility

1600 Distribution Ct

Lithia Springs, GA 30122

Central Manufacturing Facility

1700 South J Elmer Freeway, Ste 100

Cedar Hill, TX 75104

West Manufacturing Facility

1750 S Archibald Ave





Ontario, CA 91761

INVISILED® LITE+



24V LED Tape Light



Class 2 Power Supply (Required)

Model	Input	Output	Max Run	Dimming	Description
 EN-2460-RB2-T EN-24100-RB2-T	Remote 120VAC 120VAC	24VAC / 60W 24VAC / 96W	30' 40'	100%-5% ELV	Includes a 6' lead wire. UL Class 2 output.
 PS-24DC-U60R-T PS-24DC-U96R-T	Remote 120-277VAC	24VDC / 60W 24VDC / 96W	30' 40'	100%-5% ELV, TRIAC	Includes a 6' lead wire. UL Class 2 output.
 EN-24100-277-RB2-T	Remote 120-277VAC	24VDC / 96W	40'	100%-5% 0-10V	Includes a 6' lead wire. UL Class 2 output.
 EN-2460-P-AR-T EN-24100-P-AR-T	Plug-in 120VAC 120VAC	24VAC / 60W 24VAC / 96W	30' 40'	Non Dimmable	Includes a 6' lead wire. UL Class 2 output.
 EN-D24100-120-R	Wall Dimmer & Driver 120VAC	24VDC / 96W	40'	Integral	UL Class 2 output.

Indoor Controller

Model	Description
 CT-6A-R2	Lite+, Pro+, Pro2+ Touch Panel and Motion Sensor Includes a Touch Panel, Occupancy Sensor and a Controller. AC/DC input at 24V(96W Max). Connect on secondary side of power supply
 IR-96-24VACDC-WT IR-96-24VACDC-BK	White Black IR Sensor IR (Infrared sensors switch works by turning the lights on when it becomes unobstructed).

Smart Control

Model	Description
 CT-96-SM	InvisiLED® Smart Home Kit Transform your interiors with the InvisiLED® Smart Home Kit, designed exclusively for InvisiLED Lite+, Pro+, Pro2+ Tape. Control your LED tape seamlessly via Wi-Fi using the MyWAC app with devices you already own, including Amazon Alexa and Google Home. Offers on/off activation and up/down dimming capability for 24VDC systems and high-output tape lighting applications. Or use DMX to control your popular control platforms. Includes a 96W 24VDC Power Supply (EN-24DC096-UNV-RB2), wireless controller (CTR-WDMX-24VDC) and a ready-to-connect lead wire with an InvisiLED Connector (LED-TC-B-2-WT)

Model	Input	Description
 LED-WCT-WT	120-230VAC	WallStation - Multi-scene selection - Raise/Lower, dedicated Off button - Suitable for standard single NEMA wall box Setup and configuration via MyWAC mobile application - no physical adjustment needed - cUL listed

EXAMPLE INSTALLATION FOR WIRELESS AND DMX CONTROL

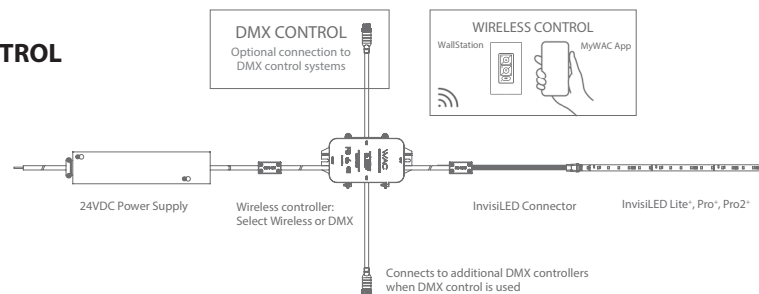

wacighting.com Phone (800) 526.2588 Fax (800) 526.2585	Headquarters, East Manufacturing Facility 44 Harbor Park Drive Port Washington, NY 11050	South East Manufacturing Facility 1600 Distribution Ct Lithia Springs, GA 30122	Central Manufacturing Facility 1700 South J Elmer Freeway, Ste 100 Cedar Hill, TX 75104	West Manufacturing Facility 1750 S Archibald Ave Ontario, CA 91761
--	---	--	--	---

INVISILED® LITE+

24V LED Tape Light

WAC

Indoor Accessories

	Model	Dimension	Finish	Description
	LED-TC-WEXT-144	12 ft	Black	In Wall Rated Extension Cable Extends distance between a hard wired power supply or a wiring box to a tape section.
	LED-TC-WEXT-144-WT	12 ft	White	
	LED-TC-WEXT-240	20 ft	Black	
	LED-TC-WEXT-240-WT	20 ft	White	
	LED-TC-WIC-144	12 ft	Black	In Wall Rated Joiner Cable Connects tape sections. 2 female ends. 1 male to male connector included.
	LED-TC-WIC-144-WT	12 ft	White	
	LED-TC-WIC-240	20 ft	Black	
	LED-TC-WIC-240-WT	20 ft	White	
	LED-TC-P-2	2 ft	Black	Lead Wire Alternative lengths for plug-in power supplies.
	LED-TC-P-2-WT	2 ft	White	
	LED-TC-P-12	12 ft	Black	
	LED-TC-P-12-WT	12 ft	White	
	LED-TC-EXT-144	12 ft	Black	Extension Cable Extends distance between a hard wired power supply or a wiring box to a tape section.
	LED-TC-EXT-144-WT	12 ft	White	
	LED-TC-B-2	L: 1½ in	Black	Low Voltage Wiring Box With Feed Neatly houses connections for up to two wires with 12" female feed.
	LED-TC-B-2-WT	W: ¾ in H: 7⁄8 in	White	
	LED-T-B	L: 1½ in W: ¾ in H: 7⁄8 in	White	Low Voltage Wiring Box Neatly houses connections for up to two wires.
	TB-S	L: 6¼ in W: 1¾ in H: 1¼ in	White	Wiring Box With Switch Use when spanning a large gap in a system layout without leaving exposed wiring. Optional switch included.
	Model	Dimension	Finish	Description
	LED-TC-IC2	2 in	Black	Joiner Cable Connects tape sections.
	LED-TC-IC2-WT	2 in	White	
	LED-TC-IC6	6 in	Black	
	LED-TC-IC6-WT	6 in	White	
	LED-TC-IC12	12 in	Black	
	LED-TC-IC12-WT	12 in	White	
	LED-TC-IC36	36 in	Black	
	LED-TC-IC36-WT	36 in	White	
	LED-TC-IC72	72 in	Black	
	LED-TC-IC72-WT	72 in	White	
	LED-TC-MM	50 Qty	Black	Connector Male to male connector.
	Model		Finish	Description
	LED-TC-Y		Black	3-Way "Y" Connector Connects tape sections.
	LED-TC-Y-WT		White	
	LED-TC-X		Black	4-Way "X" Connector Connects tape sections.
	LED-TC-X-WT		White	
	LED-TC-L		Black	"L" Connector Connects tape sections.
	LED-TC-L-WT		White	
	LED-TC-EC		Black	End Cap 1 cut and 1 male end cap.
	LED-TC-EC-WT		White	
	Model		Finish	Description
	T24-OD-SW60	5ft	Black	DMX Joiner Cable - Satellite Connect between CTR-WDMX-24VDC Master to Satellite.
	T24-OD-SW60	10ft		
	T24-OD-MW60	5ft	Black	DMX Joiner Cable Connects between DMX Universe to CTR-WDMX-24VDC
	T24-OD-MW60	10ft		

wacighting.com
Phone (800) 526.2588
Fax (800) 526.2585

Headquarters, East Manufacturing Facility
44 Harbor Park Drive
Port Washington, NY 11050

South East Manufacturing Facility
1600 Distribution Ct
Lithia Springs, GA 30122

Central Manufacturing Facility
1700 South J Elmer Freeway, Ste 100
Cedar Hill, TX 75104

West Manufacturing Facility
1750 S Archibald Ave
Ontario, CA 91761

INVISILED® LITE+

Indoor Aluminum Channels

WAC



Aluminum Channel **LED-T-CH** 5 feet
Additional End Caps **LED-T-CH-EC** 2 pcs

Diffuses light from InvisILED® tape
 Includes a diffuser, two end caps, and five screws



Deep Aluminum Channel **LED-T-CH1** 5 feet
Additional End Caps **LED-T-CH1-EC** 2 pcs

Eliminates visible hot spots
 Includes a diffuser, two end caps, and five screws



45° Angled Aluminum Channel **LED-T-CH2** 5 feet
Additional End Caps **LED-T-CH2-EC** 2 pcs

Includes a diffuser, two end caps, and five screws



Deep Aluminum Channel - Flood 54° Beam Angle **LED-T-CH3-FL** 5 feet
Additional End Caps **LED-T-CH1-EC** 2 pcs

Eliminates visible hot spots / 54° beam angles



Shallow Aluminum Channel **LED-T-CH4** 5 feet
LED-T-CH4-EC 2 pcs

Diffuses light from GEMINI tape
 Includes a diffuser, two end caps, 4 clips and 4 screws.

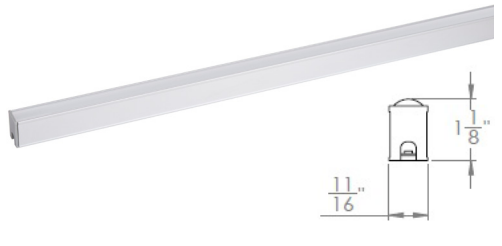

Deep Aluminum Channel - Wide Flood 84° Beam Angle **LED-T-CH3-WF** 5 feet
Additional End Caps **LED-T-CH1-EC** 2 pcs

Eliminates visible hot spots / 84° beam angles



Deep Aluminum Channel - Spot 9° Beam Angle **LED-T-CH3-SP** 5 feet
Additional End Caps **LED-T-CH1-EC** 2 pcs

Eliminates visible hot spots / 9° beam angles

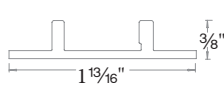

Fixed Angle Channel Clip **LED-T-CL3-PT**

Includes 2 pieces, 4 screws. Use to mount Aluminum Channel.

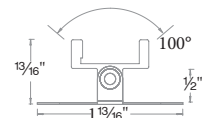

Adjustable Channel Clip **LED-T-CL2-PT**

Includes 2 pieces, 4 screws. Used to mount Aluminum Channel.
 Adjusts 50° from center either way.

INDOOR MOUNTING ACCESSORIES



Aluminum Retrofit Channel **LED-T-RC** 3 feet

Can be bent to create fixed curves or used as a glare shield



Clip **LED-T-CL**

For surfaces that are difficult to adhere.
 Includes: 10 pcs plastic clips and 10 pcs screws.
 Compatible with InvisILED Lite+, Pro+ and Pro2+ only.



Curve Clip **LED-T-CL1**

Clips to hold indoor InvisILED tapes sections. Includes: 10 pcs plastic clips and 10 pcs screws. Compatible with InvisILED Lite+, Pro+ and Pro2+ only

wacighting.com

Phone (800) 526.2588

Fax (800) 526.2585

Headquarters, East Manufacturing Facility

44 Harbor Park Drive

Port Washington, NY 11050

South East Manufacturing Facility

1600 Distribution Ct

Lithia Springs, GA 30122

Central Manufacturing Facility

1700 South J Elmer Freeway, Ste 100

Cedar Hill, TX 75104

West Manufacturing Facility

1750 S Archibald Ave

Ontario, CA 91761

INVISILED® LITE+

Symmetrical Recessed Channel

WAC

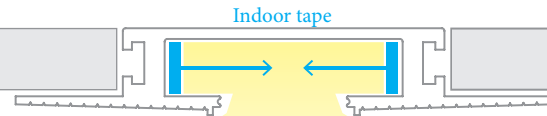

- Installs within $\frac{5}{8}$ " drywall depth
- Linear channel can be field cut
- Accommodates either one or two runs of indoor tape
- Includes a translucent white acrylic diffuser
- Dense foam insert to be removed in installation after spackling

8ft Linear Channel

LED-T-RCH1-WT

- Includes: 1 diffuser
- 8 perforated metal sheets

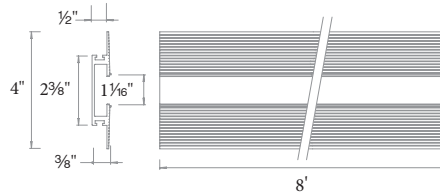

Power Feed

LED-T-RBOX1-WT

- The end cap may be placed on either side
- Hanger bars may be installed on any side of the wiring box
- Kit includes:

- 1 wiring box
- 2 hanger bars
- 4 five-pin adapters
- 2 end caps
- 1 diffuser
- 2 channel connectors
- 1 counter sink drill bit
- 1 drill bit
- 1 installation tool

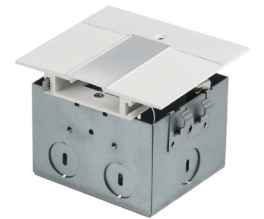
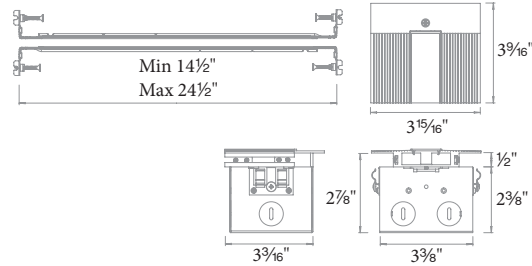

Lateral Corner

LED-T-CTC1-WT

- Includes: Diffuser
- 2 channel connectors
- 2 perforated metal sheets

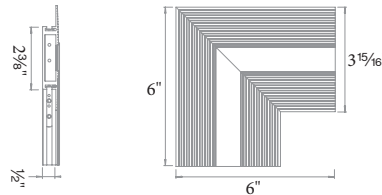

Perpendicular Corner

LED-T-WTC1-WT

- Transitions between walls or wall to ceiling
- Includes: Diffuser
- 2 channel connectors
- 2 perforated metal sheets

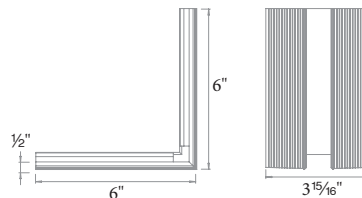

Outside Corner

LED-T-WTW1-WT

- Transitions around columns, bump outs, or soffits
- Includes: Diffuser
- 2 channel connectors
- 2 perforated metal sheets

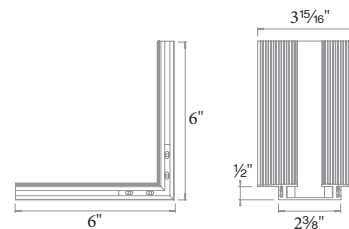

wacighting.com

Phone (800) 526.2588

Fax (800) 526.2585

Headquarters, East Manufacturing Facility

44 Harbor Park Drive

Port Washington, NY 11050

South East Manufacturing Facility

1600 Distribution Ct

Lithia Springs, GA 30122

Central Manufacturing Facility

1700 South J Elmer Freeway, Ste 100

Cedar Hill, TX 75104

West Manufacturing Facility

1750 S Archibald Ave

Ontario, CA 91761

INVISILED® LITE+

Asymmetrical Recessed Channel

WAC



Installs within 5/8" drywall depth
 Linear channel can be field cut
 Accommodates one run of indoor tape
 Dense foam insert to be removed in installation after spackling
 Recommended installation within 15 inches of surface to be illuminated

8ft Linear Channel **LED-T-RCH2-WT**

Includes: 8 perforated metal sheets
 2 channel connectors

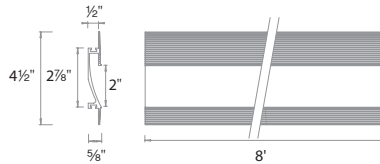

Power feed **LED-T-RBOX2-WT**

The end cap may be placed on either side
 Hanger bars may be installed on any side of the wiring box

Includes: 1 wiring box
 2 hanger bars
 2 five-pin adapters
 2 end caps (left and right)
 2 channel connectors
 1 counter sink bit
 1 drill bit

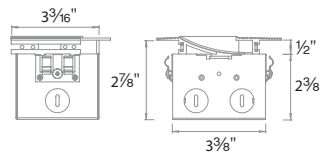
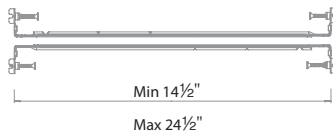

Indirect Recessed Channel

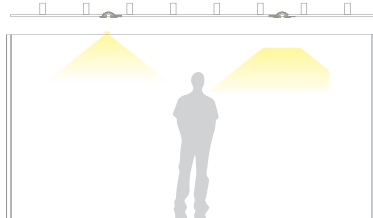

Linear channel can be field cut
 Accommodates up to four runs of indoor tape
 Dense foam insert to be removed in installation after spackling
 Allows option to use different color tape in one channel and switch them separately

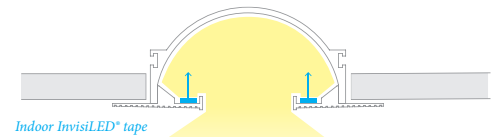

8ft Linear Channel **LED-T-RCH3-WT**

Includes: 10 perforated metal sheets
 2 channel connectors

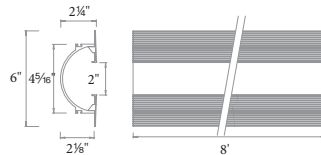

Power feed **LED-T-RBOX3-WT**

The end cap may be placed on either side
 Hanger bars may be installed on any side of the wiring box

Includes: 1 wiring box
 2 hanger bars
 4 five-pin adapters
 1 end cap
 2 channel connectors
 1 counter sink drill bit
 1 drill bit

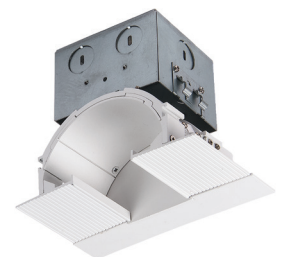
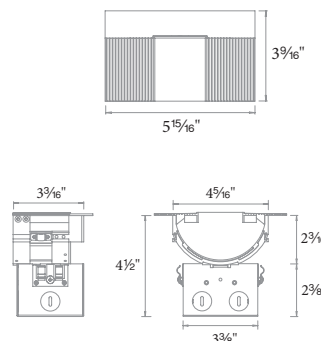
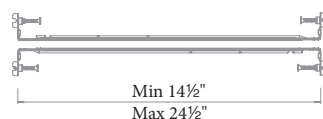

wacighting.com

Phone (800) 526.2588

Fax (800) 526.2585

Headquarters, East Manufacturing Facility

44 Harbor Park Drive

Port Washington, NY 11050

South East Manufacturing Facility

1600 Distribution Ct

Lithia Springs, GA 30122

Central Manufacturing Facility

1700 South J Elmer Freeway, Ste 100

Cedar Hill, TX 75104

West Manufacturing Facility

1750 S Archibald Ave

Ontario, CA 91761