

INVISILED® PRO 3

24V High Output Foldable LED Tape Light

WAC



Tape Section

Foldable Capability

Fixture Type:

Catalog Number:

Project:

Location:

PRODUCT DESCRIPTION

A specification grade tape light that is designed for task or accent lighting applications. This tape can be folded to create customized patterns with the help of LED-T-CL1 clips for a flattering look. Pro3 is equipped with evenly spaced diodes at 1" on the center to prevent dark spots and can be field-cut at 6" at the end of a run to perfectly fit into your interior space.

FEATURES

- Can be field cut, male to male adapter required to re-use female side
- Foldable design for lateral pattern creation
- Install LED-T-CL1 clips with folds
- Ultra thin profile at 3/8". 90° fold height of 3/8"
- Diodes spaced evenly at 1" on center
- Minimum run length of 1'
- May be field cut every 6" at the end of a run
- Three mounting methods provided for different surfaces
- 70,000 hour rated life
- 5 year WAC Lighting product warranty

SPECIFICATIONS

- Construction:** Flexible silicone cased tape light, peel and stick 3M construction adhesive on back, indicating marks for field cutting.
- Light Source:** 12 LEDs per foot, Runs on 24V at 5W per foot
- Operating Temp:** -4°F – 104°F (-20°C – 40°C), relative humidity 95%
- Standards:** UL & cUL Listed for Damp Locations

ORDER NUMBER – TAPE SECTION

Model	Watts/ft	Color Temp	CRI	Lumens/ft	Length	Qty	Tape Color	
LED-TE24 5	27	2700K	95	385	6IN	6 inches	1	WT White
	30	3000K	95	395	1	1 foot	1	
	35	3500K	90	440	5	5 feet	1	
	45	4500K	90	475	1-40	1 foot	40	

LED-TE24 ___ - ___ **-WT**

Example: **LED-TE2445-6IN-WT**

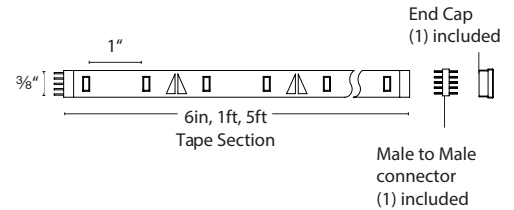

wacighting.com

Phone (800) 526.2588

Fax (800) 526.2585

Headquarters, East Manufacturing Facility

44 Harbor Park Drive

Port Washington, NY 11050

South East Manufacturing Facility

1600 Distribution Ct

Lithia Springs, GA 30122

Central Manufacturing Facility

1700 South J Elmer Freeway, Ste 100

Cedar Hill, TX 75104

West Manufacturing Facility

1750 S Archibald Ave







Ontario, CA 91761

INVISILED® PRO 3



24V High Output Foldable LED Tape Light





Class 2 Power Supply (Required)

Model	Input	Output	Max Run	Dimming	Description
 EN-2460-RB2-T EN-24100-RB2-T	120VAC	24VAC / 60W	12'	100%-5% ELV	Includes a 6' lead wire. UL Class 2 output.
 PS-24DC-U60R-T PS-24DC-U96R-T	120-277VAC	24VDC / 60W	12'	100%-5% ELV, TRIAC	Includes a 6' lead wire. UL Class 2 output.
 PS-24DC-U3X96R-T	120-277VAC	24VDC / 3 X 96W	20'	100%-5% ELV, TRIAC, 0-10V	Includes a 6' lead wire. Overload and short circuit protection.
 EN-24100-277-RB2-T	277VAC	24VDC / 96W	20'	100%-5% 0-10V	Includes a 6' lead wire. UL Class 2 output.
 EN-2460-P-AR-T EN-24100-P-AR-T	120VAC	24VAC / 60W	12'	Non Dimmable	Includes a 6' lead wire. UL Class 2 output.
 EN-D24100-120-R	120VAC	24VDC / 96W	20'	Integral	UL Class 2 output.

Indoor Controller

Model	Description
 CT-6A-R2	Pro, Pro2, Pro3, LITE Touch Panel and Motion Sensor Includes a Touch Panel, Occupancy Sensor and a Controller. AC/DC input at 12V(60W Max) or 24V(96W Max). Connect on secondary side of driver/transformer.
 IR-96-24VACDC-WT IR-96-24VACDC-BK	White Black IR Sensor IR (Infrared sensor) switch works by turning the light on when it becomes unobstructed.

Smart Control

Model	Input	Description
 CT-96-SM		InvisiLED® Smart Home Kit Transform your interiors with the InvisiLED® Smart Home Kit, designed exclusively for InvisiLED Lite, Pro, Pro 2 and Pro 3 Tape. Control your LED tape seamlessly via Wi-Fi using the MyWAC app with devices you already own, including Amazon Alexa and Google Home. Offers on/off activation and up/down dimming capability for 24VDC systems and high-output tape lighting applications. Or use DMX to control your popular control platforms. Includes a 96W 24VDC Power Supply (EN-24DC096-UNV-RB2), wireless controller (CTR-WDMX-24VDC) and a ready-to-connect lead wire with an InvisiLED Connector (LED-TC-B-2-WT)
 LED-WCT-WT	120-230VAC	WallStation - Multi-scene selection - Raise/Lower, dedicated Off button - Suitable for standard single NEMA wall box Setup and configuration via MyWAC mobile application - no physical adjustment needed - cUL listed

EXAMPLE INSTALLATION FOR WIRELESS AND DMX CONTROL

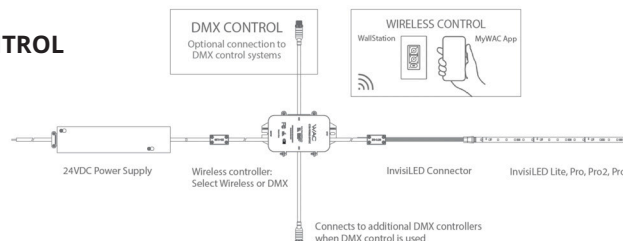

wacighting.com
 Phone (800) 526.2588
 Fax (800) 526.2585

Headquarters, East Manufacturing Facility
 44 Harbor Park Drive
 Port Washington, NY 11050

South East Manufacturing Facility
 1600 Distribution Ct
 Lithia Springs, GA 30122

Central Manufacturing Facility
 1700 South J Elmer Freeway, Ste 100
 Cedar Hill, TX 75104

West Manufacturing Facility
 1750 S Archibald Ave
 Ontario, CA 91761

INVISILED® PRO 3

24V High Output Foldable LED Tape Light



Indoor Electrical Accessories

	Model	Dimension	Finish	Description
	LED-TC-WEXT-144	12 ft	Black	In Wall Rated Extension Cable Extends distance between a hard wired power supply or a wiring box to a tape section.
	LED-TC-WEXT-144-WT	12 ft	White	
	LED-TC-WEXT-240	20 ft	Black	
	LED-TC-WEXT-240-WT	20 ft	White	
	LED-TC-WIC-144	12 ft	Black	In Wall Rated Joiner Cable Connects tape sections. 2 female ends. 1 male to male connector included.
	LED-TC-WIC-144-WT	12 ft	White	
	LED-TC-WIC-240	20 ft	Black	
	LED-TC-WIC-240-WT	20 ft	White	
	LED-TC-P-2	2 ft	Black	Lead Wire Alternative lengths for plug-in power supplies.
	LED-TC-P-2-WT	2 ft	White	
	LED-TC-P-12	12 ft	Black	
	LED-TC-P-12-WT	12 ft	White	
	LED-TC-EXT-144	12 ft	Black	Extension Cable Extends distance between a hard wired power supply or a wiring box to a tape section.
	LED-TC-EXT-144-WT	12 ft	White	
	LED-TC-B-2	L: 1½ in W: ¾ in H: 7⁄8 in	Black	Low Voltage Wiring Box With Feed Neatly houses connections for up to two wires with 12" female feed.
	LED-TC-B-2-WT		White	
	LED-T-B	L: 1½ in W: ¾ in H: 7⁄8 in	White	Low Voltage Wiring Box Neatly houses connections for up to two wires.
	TB-S	L: 6¼ in W: 1½ in H: 1¼ in	White	Wiring Box With Switch Use when spanning a large gap in a system layout without leaving exposed wiring. Optional switch included.

Compatible with Pro, Pro2, Pro3

	Model	Dimension	Finish	Description
	LED-TC-IC2	2 in	Black	Joiner Cable Connects tape sections.
	LED-TC-IC2-WT	2 in	White	
	LED-TC-IC6	6 in	Black	
	LED-TC-IC6-WT	6 in	White	
	LED-TC-IC12	12 in	Black	
	LED-TC-IC12-WT	12 in	White	
	LED-TC-IC36	36 in	Black	
	LED-TC-IC36-WT	36 in	White	
	LED-TC-IC72	72 in	Black	
	LED-TC-IC72-WT	72 in	White	



LED-TC-MM 50 Qty Black **Connector**
Male to male connector.

Compatible with Pro, Pro2, Pro3, LITE. Change directionality of tape runs and reuse cut ends of tape.

	Model	Finish	Description
	LED-TC-Y	Black	3-Way "Y" Connector Connects tape sections.
	LED-TC-Y-WT	White	
	LED-TC-X	Black	4-Way "X" Connector Connects tape sections.
	LED-TC-X-WT	White	
	LED-TC-L	Black	"L" Connector Connects tape sections.
	LED-TC-L-WT	White	
	LED-TC-EC	Black	End Cap 1 cut and 1 male end cap.
	LED-TC-EC-WT	White	

Compatible with Pro, Pro2, Pro3, LITE.

	Model	Dimension	Finish	Description
	T24-OD-SW60	5 ft	Black	DMX Joiner Cable - Satellite Connect between T24-OD-CTR Master to Satellite
	T24-OD-SW120	10 ft		
	T24-OD-MW60	5 ft	Black	DMX Joiner Cable Connect between DMX Universe to T24-OD-CTR
	T24-OD-MW120	10 ft		

INVISILED® PRO 3

Trimless Recessed Slim Channel

WAC

InvisILED Pro 3 tape



- Installs within 5/8" drywall depth
- Linear channel can be field cut
- Accommodates either one or two runs of InvisILED Pro 3 tape
- Includes a frosted acrylic diffuser

8FT LINEAR CHANNEL LED-T-RCH4-WT

Includes: 1 frosted diffuser
8 perforated metal sheets

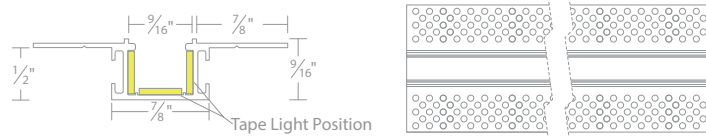

POWER FEED LED-T-RBOX4-WT

The end cap may be placed on either side.
Hanger bars may be installed on any side of the wiring box.

- Includes:** 1 wiring box
2 hanger bars
2 end caps
2 channel connectors
1 counter sink drill bit
1 drill bit
2 power to tape connectors

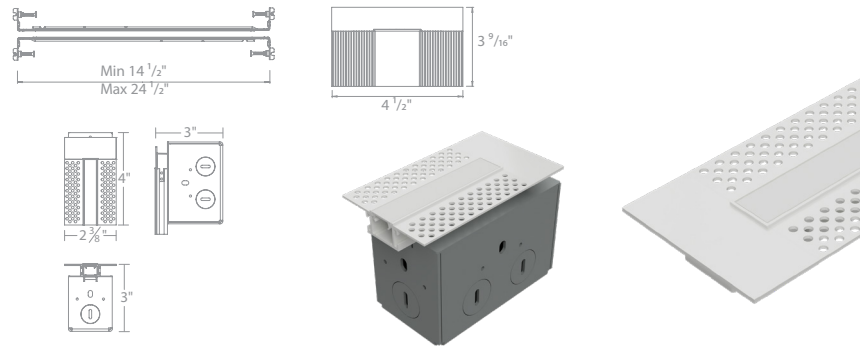

Trimmed Recessed Slim Channel

InvisILED Pro 3 tape



- Installs within 5/8" drywall depth
- Linear channel can be field cut
- Accommodates either one or two runs of InvisILED Pro 3 tape
- Includes a frosted acrylic diffuser

8FT LINEAR CHANNEL LED-T-RCH5-BK LED-T-RCH5-WT LED-T-RCH5-AL

Includes: 1 frosted diffuser
8 perforated metal sheets

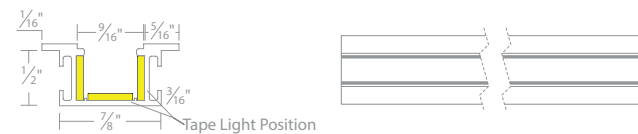

POWER FEED LED-T-RBOX5-BK LED-T-RBOX5-WT LED-T-RBOX5-AL

The end cap may be placed on either side.
Hanger bars may be installed on any side of the wiring box.

- Includes:** 1 wiring box
2 hanger bars
2 end caps
2 channel connectors
1 counter sink drill bit
1 drill bit
2 power to tape connectors

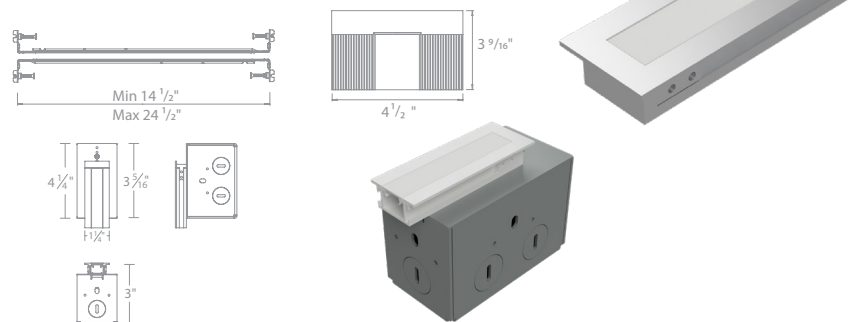

wacighting.com

Phone (800) 526.2588

Fax (800) 526.2585

Headquarters, East Manufacturing Facility

44 Harbor Park Drive

Port Washington, NY 11050

South East Manufacturing Facility

1600 Distribution Ct

Lithia Springs, GA 30122

Central Manufacturing Facility

1700 South J Elmer Freeway, Ste 100

Cedar Hill, TX 75104

West Manufacturing Facility

1750 S Archibald Ave

Ontario, CA 91761

INVISILED® PRO 3

Symmetrical Recessed Channel

WAC

InvisiLED Pro 3 tape

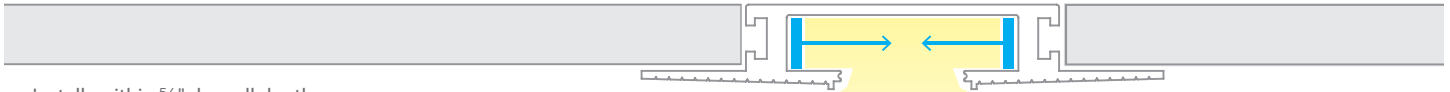

- Installs within 5/8" drywall depth
- Linear channel can be field cut
- Accommodates either one or two runs of InvisiLED Pro 3 tape
- Includes a translucent white acrylic diffuser
- Dense foam insert to be removed in installation after spackling

8FT LINEAR CHANNEL LED-T-RCH1-WT

Includes: 1 diffuser
8 perforated metal sheets

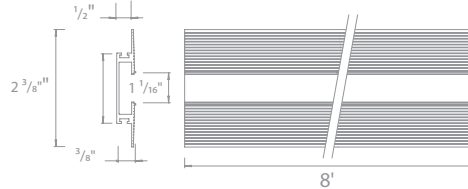

POWER FEED LED-T-RBOX1-WT

The end cap may be placed on either side.
Hanger bars may be installed on any side of the wiring box.

- Includes: 1 wiring box
2 hanger bars
4 five-pin InvisiLED® adapters
2 end caps
1 diffuser
2 channel connectors
1 counter sink drill bit
1 drill bit
1 installation tool

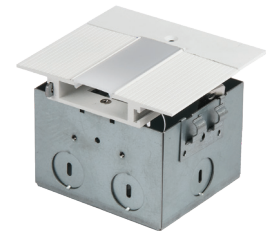
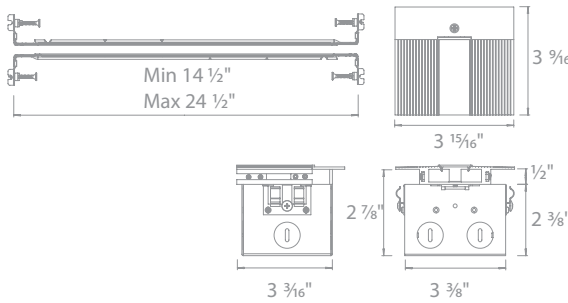

LATERAL CORNER LED-T-CTC1-WT

- Includes: 1 diffuser
2 channel connectors
2 perforated metal sheets

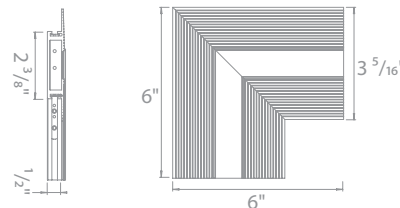

PERPENDICULAR CORNER LED-T-WTC1-WT

Transitions between walls or wall to ceiling

- Includes: 1 diffuser
2 channel connectors
2 perforated metal sheets

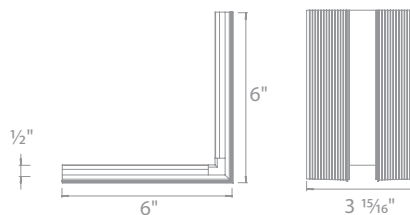

OUTSIDE CORNER LED-T-WTW1-WT

Transitions around columns, bump outs, or soffits

- Includes: 1 diffuser
2 channel connectors
2 perforated metal sheets

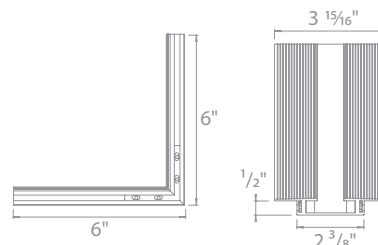

wacighting.com

Phone (800) 526.2588

Fax (800) 526.2585

Headquarters, East Manufacturing Facility

44 Harbor Park Drive

Port Washington, NY 11050

South East Manufacturing Facility

1600 Distribution Ct

Lithia Springs, GA 30122

Central Manufacturing Facility

1700 South J Elmer Freeway, Ste 100

Cedar Hill, TX 75104

West Manufacturing Facility

1750 S Archibald Ave

Ontario, CA 91761

INVISILED® PRO 3

Asymmetrical Recessed Channel

WAC

- Installs within $\frac{5}{8}$ " drywall depth
- Linear channel can be field cut
- Accommodates one run of InvisILED Pro 3 tape
- Dense foam insert to be removed in installation after spackling
- Recommended installation within 15 inches of surface to be illuminated



InvisILED Pro 3 tape

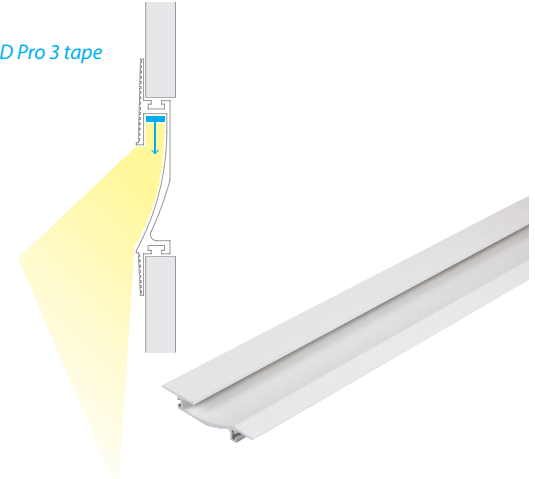

8FT LINEAR CHANNEL LED-T-RCH2-WT

Includes: 8 perforated metal sheets
2 channel connectors

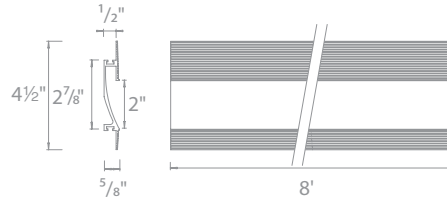

POWER FEED LED-T-RBOX2-WT

LED-T-RBOX2-WT

The end cap may be placed on either side. Hanger bars may be installed on any side of the wiring box.

- Includes: 1 wiring box
2 hanger bars
2 five-pin InvisILED® adapters
2 end caps (left and right)
2 channel connectors
1 counter sink bit
1 drill bit

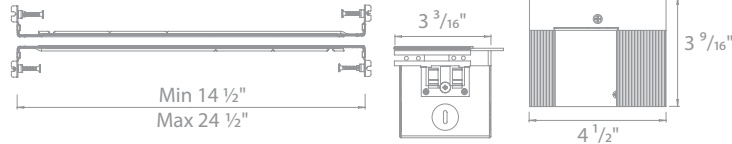

Indirect Recessed Slim Channel

- Linear channel can be field cut
- Dense foam insert to be removed in installation after spackling
- Allows option to use different color InvisILED Pro 3 tape in one channel and switch them separately

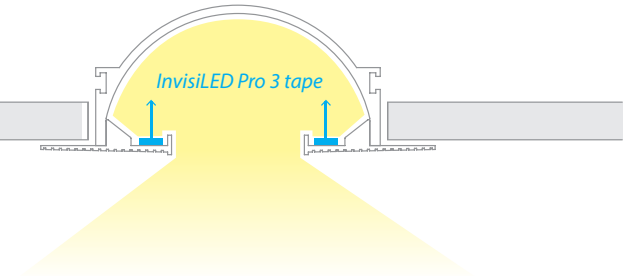
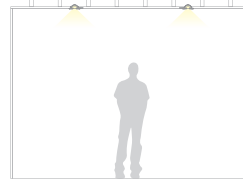

8FT LINEAR CHANNEL LED-T-RCH3-WT

Includes: 10 perforated metal sheets
2 channel connectors

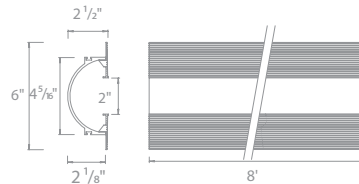

POWER FEED LED-T-RBOX3-WT

LED-T-RBOX3-WT

The end cap may be placed on either side.
Hanger bars may be installed on any side of the wiring box.

- Includes: 1 wiring box
2 hanger bars
4 five-pin InvisILED® adapters
1 end cap
2 channel connectors
1 counter sink bit
1 drill bit

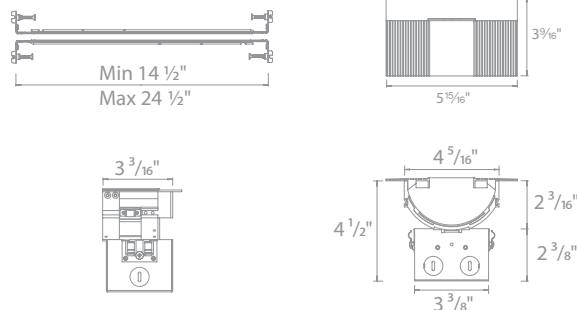

wacighting.com

Phone (800) 526.2588

Fax (800) 526.2585

Headquarters, East Manufacturing Facility

44 Harbor Park Drive

Port Washington, NY 11050

South East Manufacturing Facility

1600 Distribution Ct

Lithia Springs, GA 30122

Central Manufacturing Facility

1700 South J Elmer Freeway, Ste 100

Cedar Hill, TX 75104

West Manufacturing Facility

1750 S Archibald Ave

Ontario, CA 91761

INVISILED® PRO 3

Angled Recessed Channel

WAC

InvisiLED Pro 3 tape



- Recessed asymmetrical distribution provides a clean wash of illumination
- Linear channel can be field cut
- Accommodates one run of InvisiLED Pro 3 tape
- Includes a frosted acrylic diffuser

5FT LINEAR CHANNEL

LED-T-CH6-BK
LED-T-CH6-WT
LED-T-CH6-AL

ADDITIONAL END CAPS

LED-T-CH6-EC-BK
LED-T-CH6-EC-WT
LED-T-CH6-EC-AL

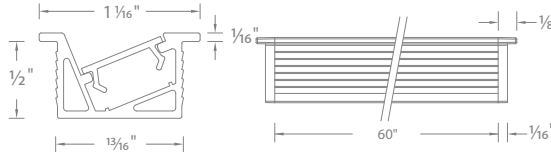

Includes: 1 frosted diffuser
2 end caps

Indoor Aluminum Channels

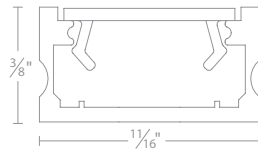

SHALLOW ALUMINUM CHANNEL

LED-T-CH5-BK
LED-T-CH5-WT
LED-T-CH5-AL

5'

ADDITIONAL END CAPS

LED-T-CH5-EC-BK
LED-T-CH5-EC-WT
LED-T-CH5-EC-AL

2 pcs

Includes a diffuser, 2 end caps, and 5 screws.

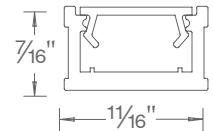

ALUMINUM CHANNEL ADDITIONAL END CAPS

LED-T-CH
LED-T-CH-EC

5'
2 pcs

Diffuses light from Gemini tape.
Includes a diffuser, 2 end caps, and 5 screws.

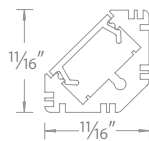

45° ANGLED ALUMINUM CHANNEL ADDITIONAL END CAPS

LED-T-CH2
LED-T-CH2-EC

5'
2 pcs

Includes a diffuser, 2 end caps, and 5 screws.

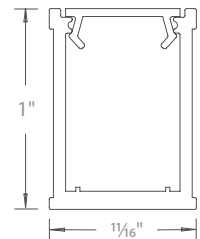

DEEP ALUMINUM CHANNEL ADDITIONAL END CAPS

LED-T-CH1
LED-T-CH1-EC

5'
2 pcs

Eliminates visible hot spots.
Includes a diffuser, 2 end caps, and 5 screws.

wacighting.com

Phone (800) 526.2588

Fax (800) 526.2585

Headquarters, East Manufacturing Facility

44 Harbor Park Drive

Port Washington, NY 11050

South East Manufacturing Facility

1600 Distribution Ct

Lithia Springs, GA 30122

Central Manufacturing Facility

1700 South J Elmer Freeway, Ste 100

Cedar Hill, TX 75104

West Manufacturing Facility

1750 S Archibald Ave

Ontario, CA 91761

INVISILED® PRO 3

Indoor Mounting Accessories

WAC



ALUMINUM RETROFIT CHANNEL LED-T-RC 3 feet

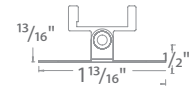

ADJUSTABLE CHANNEL CLIP LED-T-CL2-PT

Includes 2 pieces, 4 screws. Used to mount Aluminum Channel. Adjust 50° from center either way.



FIXED ANGLE CHANNEL CLIP LED-T-CL3-PT



Clip LED-T-CL **Curve Clip** LED-T-CL1

For surfaces that are difficult to adhere. Includes: 10 pcs plastic clips and 10 pcs screws. Compatible with InvisILED Lite+, Pro+ and Pro2+ only.

Clips to hold indoor InvisILED tapes sections. Includes: 10 pcs plastic clips and 10 pcs screws. Compatible with InvisILED Lite+, Pro+ and Pro2+ only

Optical Channels and Lens Accessories



FROSTED DIFFUSER LED-T-CH5-COV-FR 5'
LED-T-CH8-COV-FR 8'

Standard diffuser included with channel.



SPOT OPTIC DEEP CHANNEL LED-T-CH3-SP 5'
ADDITIONAL END CAPS LED-T-CH1-EC 2 pcs

Eliminates visible hot spots. Includes a diffuser, 2 end caps, and 5 screws.

Spot 9° Beam Angle

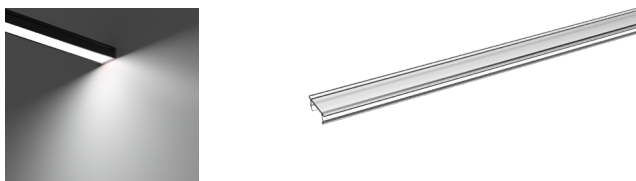

SEMI-CLEAR DIFFUSER LED-T-CH5-COV-SF 5'
LED-T-CH8-COV-SF 8'

Optional diffuser available, order separately.



FLOOD OPTIC DEEP CHANNEL LED-T-CH3-FL 5'
ADDITIONAL END CAPS LED-T-CH1-EC 2 pcs

Eliminates visible hot spots. Includes a diffuser, 2 end caps, and 5 screws.

Flood 54° Beam Angle

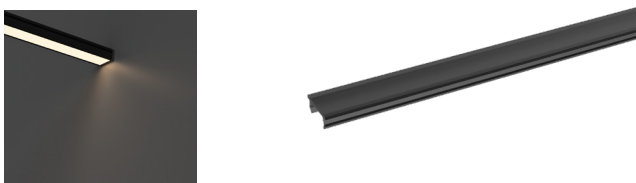

BLACK DIFFUSER LED-T-CH5-COV-BK 5'
LED-T-CH8-COV-BK 8'

Optional diffuser available, order separately.



WIDE FLOOD OPTIC DEEP CHANNEL LED-T-CH3-WF 5'
ADDITIONAL END CAPS LED-T-CH1-EC 2 pcs

Eliminates visible hot spots. Includes a diffuser, 2 end caps, and 5 screws.

Wide Flood 84° Beam Angle

wacighting.com
Phone (800) 526.2588
Fax (800) 526.2585

Headquarters, East Manufacturing Facility
44 Harbor Park Drive
Port Washington, NY 11050

South East Manufacturing Facility
1600 Distribution Ct
Lithia Springs, GA 30122

Central Manufacturing Facility
1700 South J Elmer Freeway, Ste 100
Cedar Hill, TX 75104

West Manufacturing Facility
1750 S Archibald Ave
Ontario, CA 91761