

STRAIGHT EDGE PRO

LED Cabinet and Niche Lighting LS-LED

WAC

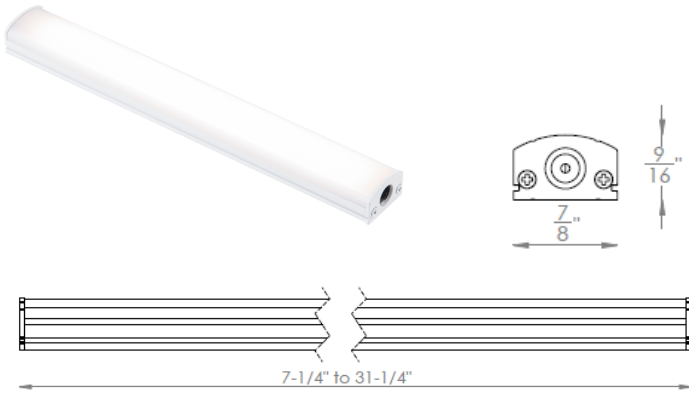

Fixture Type:

Catalog Number:

Project:

Location:

PRODUCT DESCRIPTION

Low power consumption and strong lumen output make this low-profile LED strip light system perfect for small coves and niches, cabinets, shelves and bookcases.

FEATURES

- Available in 5 lengths
- Multiple connectors and cables available to facilitate custom layouts
- Four mounting options provided for different surfaces
- Each section includes 2 flat mounting clips, 2 45° angle mounting clips and 1 "I" connector
- Adjustable angle mounting clips allow fixture to be easily aimed while securely mounted for optimal task lighting performance and flexibility
- 120° beam spread
- Free of projected heat, UV and IR radiation
- 70,000 hour rated life
- 5 year WAC Lighting product warranty
- Frosted Lens, no LED hotspot

SPECIFICATIONS

Construction: Extruded aluminum body with a polycarbonate diffused lens.

Power Supply: Remote and plug-in electronic Class 2 transformers. 120VAC and 277VDC 50/60Hz input, 24V 60W and 96W output.

Light Source: Integrated LED in 2700K, 3000K, and 3500K

Dimming: May be dimmed to 1% with electronic low voltage (ELV) dimmer.

Finish: Abrasion resistant White (WT) powder coat finish.

Standards: UL & CUL Listed for use in damp locations.

ORDER NUMBER

Model #	Length	Color Temp	Finish
LS-LED08P	7¼"	27 2700K	WT White
LS-LED14P	13¾"		
LS-LED20P	19¼"	30 3000K	
LS-LED26P	25¼"	35 3500K	
LS-LED32P	31¼"		



Example: LS-LED14P-30-WT

FIXTURE PERFORMANCE

Model #	Color Temp	Power	Lumens	Efficacy	CRI
LS-LED08P-27	2700K	2.6W	180	69 Lm/W	90
LS-LED14P-27	2700K	4.7W	335	71 Lm/W	90
LS-LED20P-27	2700K	7.4W	520	70 Lm/W	90
LS-LED26P-27	2700K	9.5W	670	71 Lm/W	90
LS-LED32P-27	2700K	12.0W	850	71 Lm/W	90
LS-LED08P-30	3000K	2.6W	185	71 Lm/W	90
LS-LED14P-30	3000K	4.7W	345	73 Lm/W	90
LS-LED20P-30	3000K	7.4W	535	72 Lm/W	90
LS-LED26P-30	3000K	9.5W	695	73 Lm/W	90
LS-LED32P-30	3000K	12.0W	880	73 Lm/W	90
LS-LED08P-35	3500K	2.6W	190	73 Lm/W	90
LS-LED14P-35	3000K	4.7W	355	76 Lm/W	90
LS-LED20P-35	3500K	7.4W	555	75 Lm/W	90
LS-LED26P-35	3500K	9.5W	720	76 Lm/W	90
LS-LED32P-35	3500K	12.0W	910	76 Lm/W	90

MAX RUN

Model #	60W Transformer	96W Transformer
LS-LED08P	20 pieces	36 pieces
LS-LED14P	12 pieces	20 pieces
LS-LED20P	8 pieces	13 pieces
LS-LED26P	6 pieces	10 pieces
LS-LED32P	5 pieces	8 pieces

POWER SUPPLIES

Plug-in

EN-2460-P-AR-S	120VAC/60W Class 2 LED transformer
EN-24100-P-AR-S	120VAC/96W Class 2 LED transformer

Remote (Hard-Wired)

EN-2460-RB2-S	120VAC/60W Class 2 LED transformer
EN-24100-RB2-S	120VAC/96W Class 2 LED transformer
EN-24100-277-RB2-T	277VDC/96W Class 2 LED transformer

POWER SUPPLY ACCESSORIES

TB-S	Wiring box with switch
MTB	Multiple terminal block
SL-EXT-144	12' extension cable
SL-WC-1	Wire Clip

For full descriptions and specs of Power Supplies and all Accessories see next pages.

wacighting.com
Phone (800) 526.2588
Fax (800) 526.2585

Headquarters/Eastern Distribution Center
44 Harbor Park Drive
Port Washington, NY 11050

Central Distribution Center
1600 Distribution Ct
Lithia Springs, GA 30122



Western Distribution Center
1750 Archibald Avenue
Ontario, CA 91760

STRAIGHT EDGE PRO





LED Cabinet and Niche Lighting LS-LED



POWER SUPPLIES

			Input	Output		
120V AC Plug-in Class 2 Transformer		EN-2460-P-AR-S EN-24100-P-AR-S	120V 120V	24V/60W 24V/96W	2¾" × 1⅝" × 1¾" 4⅝" × 2" × 1⅝"	May be dimmed. Includes 6' cord and five SL-WC-1 plastic wire clips.
120V AC Remote Class 2 Transformer		EN-2460-RB2-S EN-24100-RB2-S	120V 120V	24V/60W 24V/96W	6½" × 1⅝" × 1¾"	May be dimmed. Includes 6' cord and five SL-WC-1 plastic wire clips.
120-277V DC Remote Class 2 Power Supply		EN-24100-277-RB2-T	120- 277V	24V/96W	12⅝" × 3¼" × 2"	May be 0-10V dimmed. Includes 6' cord and Straight Edge connector.

POWER SUPPLY ACCESSORIES





Wiring box with switch		TB-S		6¼" × 1⅝" × 1¾"	Use when spanning a large gap in a system layout without leaving exposed wiring (ie: lighting kitchen cabinets on both sides of a sink or window). Low voltage wiring is collected inside box, with Romex® wire output to go behind a wall.
Multiple Terminal Block		MTB-06 6 outputs MTB-08 8 outputs		4⅞" × 1⅝" × ¾" 4⅞" × 1⅝" × ¾"	Easily wire multiple output connections for a neat installation without the use of open splices. One power supply input and either 6 or 8 outputs. 5A capacity. Three mounting screws included.
12' Extension Cable		SL-EXT-144		Wire: 144" Connector: 1⅝"	Use to extend the distance between power supply or wiring box (TB-S) to a Straight Edge section.
Wire Clip (10 Pack)		SL-WC-1		½" × ⅜"	Use to tack power cords or joiner cables neatly to a surface.

STRAIGHT EDGE PRO



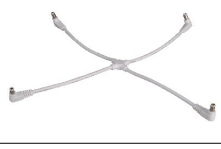

LED Cabinet and Niche Lighting LS-LED



CONNECTION ACCESSORIES

"I" Connector		SL-I	Ø¼" × 7⁄8"	For end-to-end connection of Straight Edge sections. <i>(One included with each Straight edge section).</i>
Joiner Cables		SL-IC-06 SL-IC-12 SL-IC-24 SL-IC-36	6" 12" 24" 36"	Connects two sections of Straight Edge.
Custom Cable Extenders		SL-IF	Ø³⁄⁸" × 3⁵⁄⁸"	Two female ends. Connects two joiner cables to create custom lengths.
4-way "X" connector		SL-X	Wires: 4" each Connectors: 1½" each	"X" connector has four male connectors and can be used to easily customize your design layout.
3-way "Y" connector		SL-Y	Wires: 4" each Connectors: 1½" each	"Y" connector has three male connectors and can be used to easily customize your design layout.

MOUNTING ACCESSORIES

Flat Mounting Clip		SL-C1-WT	1" × ⅞" × 1¼"	Metal clip used to mount Straight Edge sections flat to a surface. <i>(Two included with each Straight Edge section).</i>
45° Angle Mounting Clip		SL-C2-WT	1" × 1" × 1½"	Metal clip used to mount Straight Edge sections in corners. <i>(Two included with each Straight Edge section).</i>
Adjustable Angle Mounting Clip		SL-C3-WT	⅝" × ⅝" × 1¾"	Metal clip used to mount Straight Edge sections at variable angles.
Magnetic Tape		MAG-TAPE-36	36" × ¾"	One magnetic side and one peel and stick side for mounting Straight Edge sections to a metal surface. Easily cut in field.