

INVISILED® Duet

Color Temperature Adjustable LED Tape

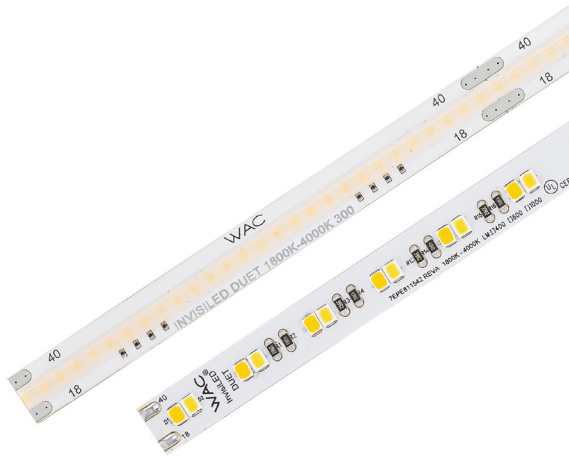

Fixture Type:

Catalog Number:

Project: _____

Location: _____

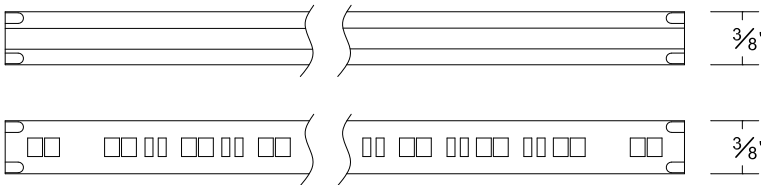

PRODUCT DESCRIPTION

INVISILED Duet technology features two wires that are easy to install while supplying both power and control. With a high 90-plus CRI, Tunable White, and Dim-to-Warm built-in technology, the InvisILED Duet tape is a symphony of light. Control the tape seamlessly via the WAC Home control system.

FEATURES

- Tune to desired CCT and intensity
- Uniform brightness with advanced Chip-on-Board LEDs
- Strong adhesive bonding with the 3M adhesive VHB
- May be cut and easily reconnected every 4 inches
- Closet Rated options (DU1, DU2, DU3)
- DU1, DU2, DU3, DU4: Available in COB (Chip-on-Board) style for seamless, uniform light output. DU6, DU10: Available in discrete LED style for defined, individual light points.

SPECIFICATIONS

Construction:	Flexible strip light
Cutting Interval:	4"
Input:	24VDC
Lumens:	Up to 1000 lm/ft
Max Run:	Refer to ordering table
CRI:	90
Color Temp:	1800K - 4000K / 2700K-5000K
Rated Life:	50,000 hours
Operating Temp:	-4°F to 104°F (-20°C to 40°C)
Standards:	UL & cUL listed, Damp Location listed, Title 24 Compliant

TAPE SELECTIONS

System	Max Run	Power	Length (in feet)					Color Temp	Finish
T24-DU1	100+lm/ft	60 ft	1.2W/ft	01	05	10	20	60	A 1800-4000K B 2700-5000K White
T24-DU2	200+lm/ft	40 ft	2.3W/ft	01	05	10	20	40	
T24-DU3	300+lm/ft	30 ft	3.5W/ft	01	05	10	20	30	
T24-DU4	400+lm/ft	20 ft	4.7W/ft	01	05	10	20	N/A	
T24-DU6	600+lm/ft	15 ft	5.4W/ft	01	05	10	15	N/A	
T24-DU10	1000+lm/ft	10 ft	8.3W/ft	01	05	10	N/A	N/A	









Example: **T24-DU3-20-B**

wacighting.com	Headquarters, East Manufacturing Facility	South East Manufacturing Facility	Central Manufacturing Facility	West Manufacturing Facility
Phone (800) 526.2588	44 Harbor Park Drive	1600 Distribution Ct	1700 South J Elmer Freeway, Ste 100	1750 S Archibald Ave
Fax (800) 526.2585	Port Washington, NY 11050	Lithia Springs, GA 30122	Cedar Hill, TX 75104	Ontario, CA 91761

INVISILED® Duet

Power Supplies and Accessories



	MODEL	Finish			
	T24-DU-PM-CL	Clear	Power to Tape Connector Connects power cable to tape (10 pieces per pack)		
	T24-DU-MM-CL	Clear	Tape to Tape Connector Connects tape sections (10 pieces per pack)		
	T24-DU-L-CL	Clear	Tape to Tape L Connector Connects tape sections (2 pieces per pack)		
	T24-DU-Y-WT T24-DU-Y-BK	White Black	Flex Y Connector Connects tape sections		
	T24-DU-X-WT T24-DU-X-BK	White Black	Flex X Connector Connects tape sections		
	T24-DU-IC-002 T24-DU-IC-006 T24-DU-IC-012 T24-DU-IC-036 T24-DU-IC-072	WT White BK Black	Joiner Cable Connects tape sections, 2 male ends In wall rated wire	2 in 6 in 1 ft 3 ft 6 ft	Example: T24-DU-IC-002-WT
	T24-DU-EX2-072 T24-DU-EX2-144 T24-DU-EX2-240 T24-DU-EX2-480	WT White BK Black	Extension Cable Extends distance between a hard wire power supply or a wiring box to a tape section In wall rated wire	6 ft 12 ft 20 ft 40 ft	Example: T24-DU-EX2-072-WT
	T24-DU-CL	Clear	Plastic Mounting Clip For installation on non-flat surfaces Include 10 pcs plastic mounting clips and 10 screw		
	LED-T-B	White	Low voltage Wiring Box Neatly house connections for up to 2 wires		

Example: **T24-DU-IC-006-WT**

Power Supply + Controller (PSC)

	MODEL	Input	Output	Dimension	Description
	PS-24DC-96R-TW-DU	120-277VAC	24VDC 96W	7 11/16" x 4 11/16" x 1 3/8"	> 0.9 pf Overload and short circuit protection Includes 6ft lead wire with connector

wacighting.com

Phone (800) 526.2588

Fax (800) 526.2585

Headquarters, East Manufacturing Facility

44 Harbor Park Drive

Port Washington, NY 11050

South East Manufacturing Facility

1600 Distribution Ct

Lithia Springs, GA 30122

Central Manufacturing Facility

1700 South J Elmer Freeway, Ste 100

Cedar Hill, TX 75104

West Manufacturing Facility

1750 S Archibald Ave

Ontario, CA 91761

INVISILED® Duet

Trimless Recessed Slim Channel



Indoor InvisILED tape



- Installs within 5/8" drywall depth
- Linear channel can be field cut
- Accommodates either one or two runs of InvisILED indoor tape
- Includes a frosted acrylic diffuser

8FT LINEAR CHANNEL LED-T-RCH4-WT

Includes: 1 frosted diffuser
8 perforated metal sheets

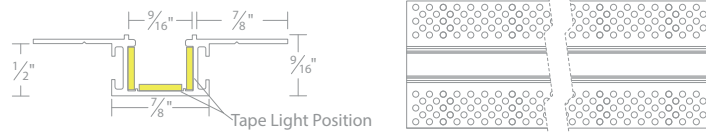

POWER FEED LED-T-RBOX4-WT

The end cap may be placed on either side.
Hanger bars may be installed on any side of the wiring box.

- Includes:** 1 wiring box
2 hanger bars
2 end caps
2 channel connectors
1 counter sink drill bit
1 drill bit
2 power to tape connectors

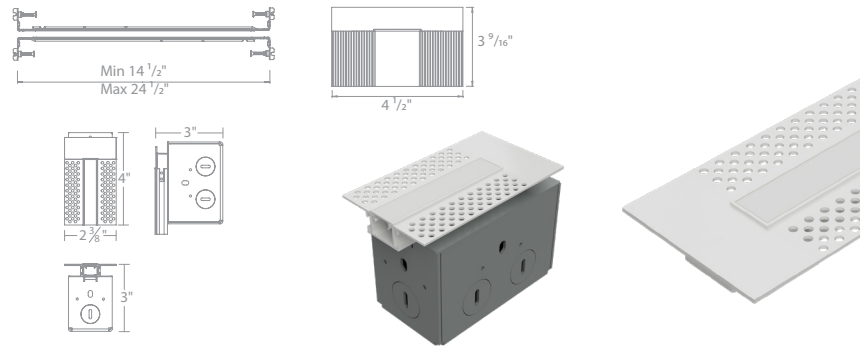

Trimmed Recessed Slim Channel

Indoor InvisILED tape

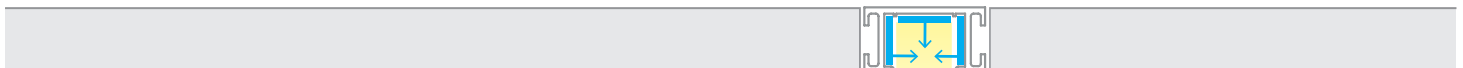

- Installs within 5/8" drywall depth
- Linear channel can be field cut
- Accommodates either one or two runs of InvisILED indoor tape
- Includes a frosted acrylic diffuser

8FT LINEAR CHANNEL LED-T-RCH5-BK LED-T-RCH5-WT LED-T-RCH5-AL

Includes: 1 frosted diffuser
8 perforated metal sheets

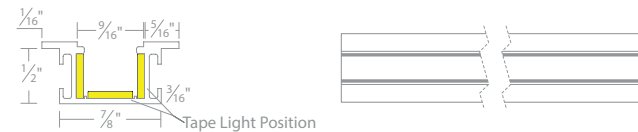

POWER FEED LED-T-RBOX5-BK LED-T-RBOX5-WT LED-T-RBOX5-AL

The end cap may be placed on either side.
Hanger bars may be installed on any side of the wiring box.

- Includes:** 1 wiring box
2 hanger bars
2 end caps
2 channel connectors
1 counter sink drill bit
1 drill bit
2 power to tape connectors

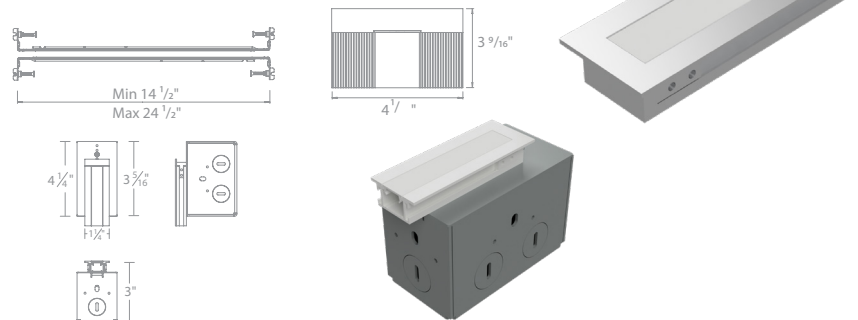

INVISILED® Duet

Symmetrical Recessed Channel

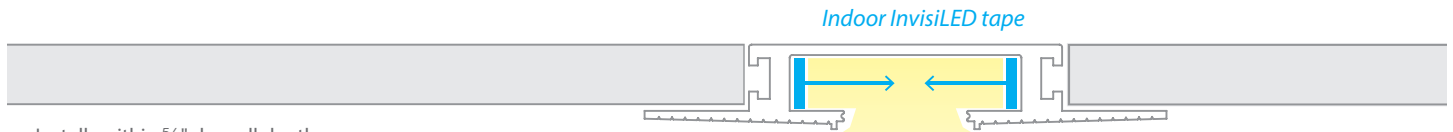

- Installs within 5/8" drywall depth
- Linear channel can be field cut
- Accommodates either one or two runs of InvisILED indoor tape
- Includes a translucent white acrylic diffuser
- Dense foam insert to be removed in installation after spackling

8FT LINEAR CHANNEL LED-T-RCH1-WT

- Includes: 1 diffuser
8 perforated metal sheets

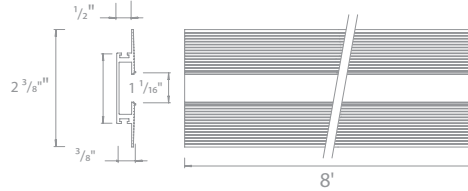

POWER FEED LED-T-RBOX1-WT

The end cap may be placed on either side.
Hanger bars may be installed on any side of the wiring box.

- Includes: 1 wiring box
2 hanger bars
4 five-pin InvisILED® adapters
2 end caps
1 diffuser
2 channel connectors
1 counter sink drill bit
1 drill bit
1 installation tool

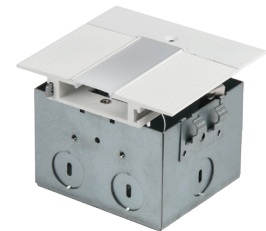
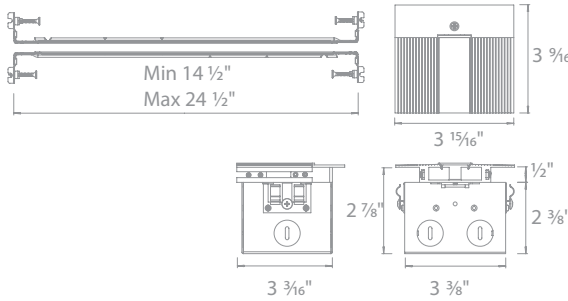

LATERAL CORNER LED-T-CTC1-WT

- Includes: 1 diffuser
2 channel connectors
2 perforated metal sheets

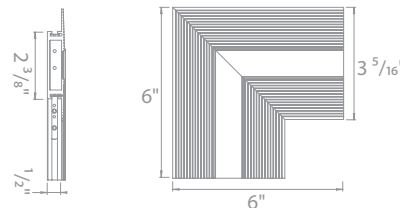

PERPENDICULAR CORNER LED-T-WTC1-WT

Transitions between walls or wall to ceiling

- Includes: 1 diffuser
2 channel connectors
2 perforated metal sheets

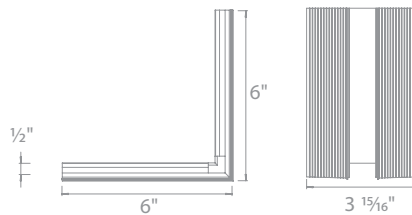

OUTSIDE CORNER LED-T-WTW1-WT

Transitions around columns, bump outs, or soffits

- Includes: 1 diffuser
2 channel connectors
2 perforated metal sheets

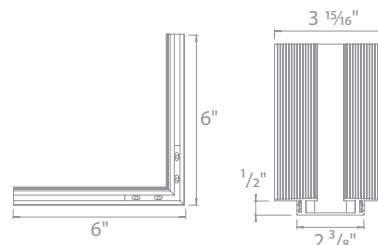

wacighting.com

Phone (800) 526.2588

Fax (800) 526.2585

Headquarters, East Manufacturing Facility

44 Harbor Park Drive

Port Washington, NY 11050

South East Manufacturing Facility

1600 Distribution Ct

Lithia Springs, GA 30122

Central Manufacturing Facility

1700 South J Elmer Freeway, Ste 100

Cedar Hill, TX 75104

West Manufacturing Facility

1750 S Archibald Ave

Ontario, CA 91761

INVISILED® Duet

Asymmetrical Recessed Channel



- Installs within 5/8" drywall depth
- Linear channel can be field cut
- Accommodates one run of InvisILED indoor tape
- Dense foam insert to be removed in installation after spackling
- Recommended installation within 15 inches of surface to be illuminated

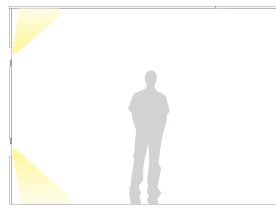

Indoor InvisILED tape

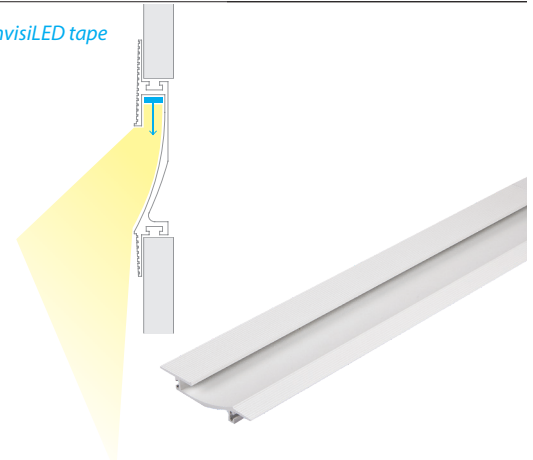

8FT LINEAR CHANNEL LED-T-RCH2-WT

Includes: 8 perforated metal sheets
2 channel connectors

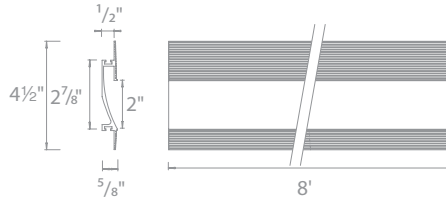

POWER FEED LED-T-RBOX2-WT

The end cap may be placed on either side. Hanger bars may be installed on any side of the wiring box.

- Includes:
- 1 wiring box
 - 2 hanger bars
 - 2 five-pin InvisILED® adapters
 - 2 end caps (left and right)
 - 2 channel connectors
 - 1 counter sink bit
 - 1 drill bit

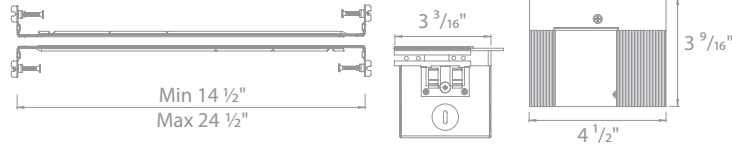

Indirect Recessed Slim Channel

- Linear channel can be field cut
- Dense foam insert to be removed in installation after spackling
- Allows option to use different color InvisILED in one channel and switch them separately

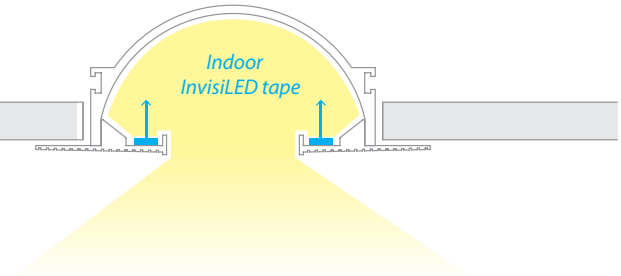
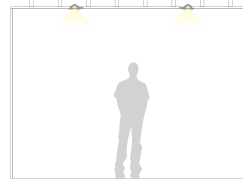

8FT LINEAR CHANNEL LED-T-RCH3-WT

Includes: 10 perforated metal sheets
2 channel connectors

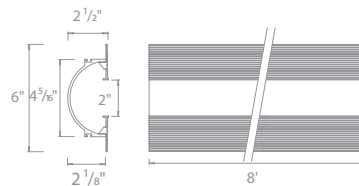

POWER FEED LED-T-RBOX3-WT

The end cap may be placed on either side.
Hanger bars may be installed on any side of the wiring box.

- Includes:
- 1 wiring box
 - 2 hanger bars
 - 4 five-pin InvisILED® adapters
 - 1 end cap
 - 2 channel connectors
 - 1 counter sink bit
 - 1 drill bit

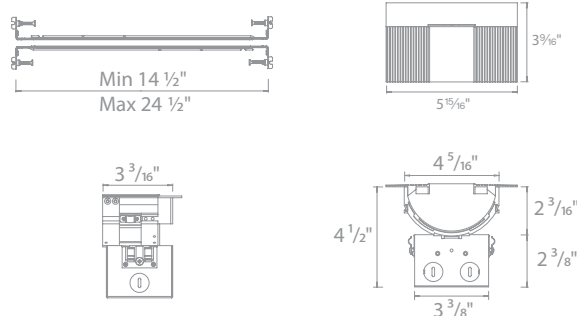

wacighting.com

Phone (800) 526.2588

Fax (800) 526.2585

Headquarters, East Manufacturing Facility

44 Harbor Park Drive

Port Washington, NY 11050

South East Manufacturing Facility

1600 Distribution Ct

Lithia Springs, GA 30122

Central Manufacturing Facility

1700 South J Elmer Freeway, Ste 100

Cedar Hill, TX 75104

West Manufacturing Facility

1750 S Archibald Ave

Ontario, CA 91761

INVISILED® Duet

Angled Recessed Channel



Indoor InvisiLED tape



- Recessed asymmetrical distribution provides a clean wash of illumination
- Linear channel can be field cut
- Accommodates one run of InvisiLED indoor tape
- Includes a frosted acrylic diffuser

5FT LINEAR CHANNEL

LED-T-CH6-BK
LED-T-CH6-WT
LED-T-CH6-AL

ADDITIONAL END CAPS

LED-T-CH6-EC-BK
LED-T-CH6-EC-WT
LED-T-CH6-EC-AL

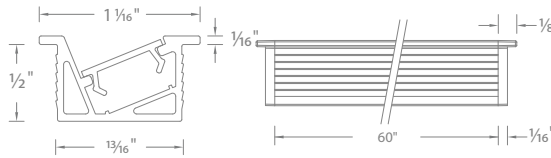

Includes: 1 frosted diffuser
2 end caps

Indoor Aluminum Channels

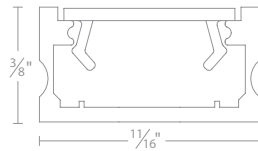

SHALLOW ALUMINUM CHANNEL

LED-T-CH5-BK
LED-T-CH5-WT
LED-T-CH5-AL

ADDITIONAL END CAPS

LED-T-CH5-EC-BK
LED-T-CH5-EC-WT
LED-T-CH5-EC-AL

Includes a diffuser, 2 end caps, and 5 screws.

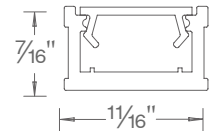

ALUMINUM CHANNEL ADDITIONAL END CAPS

LED-T-CH 5'
LED-T-CH-EC 2 pcs

Diffuses light from InvisiLED tape.
Includes a diffuser, 2 end caps, and 5 screws.

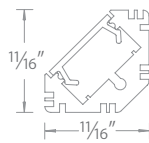

45° ANGLED ALUMINUM CHANNEL ADDITIONAL END CAPS

LED-T-CH2 5'
LED-T-CH2-EC 2 pcs

Includes a diffuser, 2 end caps, and 5 screws.

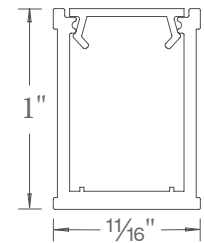

DEEP ALUMINUM CHANNEL ADDITIONAL END CAPS

LED-T-CH1 5'
LED-T-CH1-EC 2 pcs

Eliminates visible hot spots.
Includes a diffuser, 2 end caps, and 5 screws.

wacighting.com

Phone (800) 526.2588

Fax (800) 526.2585

Headquarters, East Manufacturing Facility

44 Harbor Park Drive

Port Washington, NY 11050

South East Manufacturing Facility

1600 Distribution Ct

Lithia Springs, GA 30122

Central Manufacturing Facility

1700 South J Elmer Freeway, Ste 100

Cedar Hill, TX 75104

West Manufacturing Facility

1750 S Archibald Ave

Ontario, CA 91761

INVISILED® Duet

Indoor Mounting Accessories



ALUMINUM RETROFIT CHANNEL **LED-T-RC** 3 feet

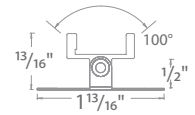

ADJUSTABLE CHANNEL CLIP **LED-T-CL2-PT**

Includes 2 pieces, 4 screws. Used to mount Aluminum Channel.
Adjust 50° from center either way.

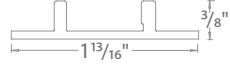
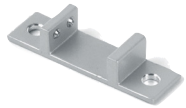

FIXED ANGLE CHANNEL CLIP **LED-T-CL3-PT**

Optical Channels and Lens Accessories

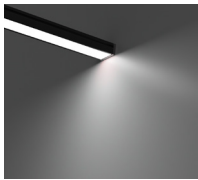

FROSTED DIFFUSER **LED-T-CH5-COV-FR** 5'
 LED-T-CH8-COV-FR 8'

Standard diffuser included with channel.



SPOT OPTIC DEEP CHANNEL **LED-T-CH3-SP** 5'
ADDITIONAL END CAPS **LED-T-CH1-EC** 2 pcs

Eliminates visible hot spots.
Includes a diffuser, 2 end caps, and 5 screws.

Spot 9° Beam Angle



SEMI-CLEAR DIFFUSER **LED-T-CH5-COV-SF** 5'
 LED-T-CH8-COV-SF 8'

Optional diffuser available, order separately.



FLOOD OPTIC DEEP CHANNEL **LED-T-CH3-FL** 5'
ADDITIONAL END CAPS **LED-T-CH1-EC** 2 pcs

Eliminates visible hot spots.
Includes a diffuser, 2 end caps, and 5 screws.

Flood 54° Beam Angle



BLACK DIFFUSER **LED-T-CH5-COV-BK** 5'
 LED-T-CH8-COV-BK 8'

Optional diffuser available, order separately.

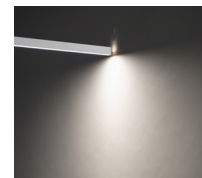

WIDE FLOOD OPTIC DEEP CHANNEL **LED-T-CH3-WF** 5'
ADDITIONAL END CAPS **LED-T-CH1-EC** 2 pcs

Eliminates visible hot spots.
Includes a diffuser, 2 end caps, and 5 screws.

Wide Flood 84° Beam Angle

wacighting.com
Phone (800) 526.2588
Fax (800) 526.2585

Headquarters, East Manufacturing Facility
44 Harbor Park Drive
Port Washington, NY 11050

South East Manufacturing Facility
1600 Distribution Ct
Lithia Springs, GA 30122

Central Manufacturing Facility
1700 South J Elmer Freeway, Ste 100
Cedar Hill, TX 75104

West Manufacturing Facility
1750 S Archibald Ave
Ontario, CA 91761